

Power Lift & Recline Chair

OWNER'S MANUAL AND LIMITED LIFETIME WARRANTY



PR445-MED



401 Bridge Street
Old Forge, PA 18518
www.goldentech.com

Dear Valued Customer,

Thank you for purchasing this Golden Technologies Power Lift and Recline Chair. We are committed to providing our customers with the highest quality lift chairs

We believe that this product is made from the highest quality components available, is engineered to give you maximum service with minimum maintenance, and is backed by the strongest warranty in the industry. We hope that your Golden chair provides years of comfort and enjoyment, while assisting you in both sitting down and standing up.

Please take a few moments to review this manual to become familiar with the operation of this chair and our warranty. If you need additional information, please call the dealer from whom you purchased this chair.

Also, please note the following safety information: This power lift and recline chair is a medical device designed to help you sit down and stand up. Do not allow children to operate the chair at any time. When not in use, the chair should be kept in the sitting position.

Again, thank you for selecting this Golden chair.

Sincerely,

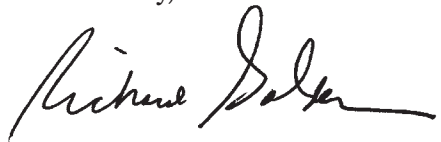

Richard Golden
Chief Executive Officer



Complies with
UL 73 and
CSA C22.2 No. 68

Safety Guidelines

The symbols below are used in the owner's manual and/or on the product to identify warnings and notify you of important safety information. Make sure you read and understand them completely.



WARNING! Indicate(s) a hazardous situation which, if not avoided, could result in death or serious injury. This icon is represented as a black symbol on a yellow triangle with a black border.



MANDATORY! Failure to perform mandatory actions could cause personal injury and/or equipment damage. This icon is represented as a white symbol on a blue dot with a white border.



PROHIBITED! Indicate(s) an action(s) that should not be performed under any circumstance. Failure to adhere could cause personal injury and/or equipment damage. This icon is represented as a black symbol with a red circle and red slash.

Safety Symbols

The symbols below identify warnings, mandatory actions, and prohibited actions. They can be found in the owner's manual and/or on the product. Make sure you understand all safety labels before operating the product. **Do not** remove safety labels from your product.



Read and follow owner's manual!



Child and/or Pet Crush Hazard!



Pinch/Crush Point Hazard!



Transformer Crush Hazard!



Adult, Child and/or Pet Tip Over Hazard!



Fire Hazard!



Safety Guidelines

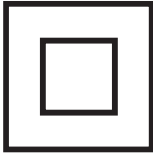

Class II Device!



Indoor use only!



Do Not Smoke!

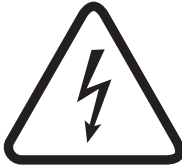

Electrical hazard!



Do not dispose in trash!



Batteries required!



MANDATORY

READ THIS MANUAL FIRST BEFORE INSTALLING OR OPERATING YOUR POWER LIFT AND RECLINE CHAIR.

Your power lift and recline chair has been engineered from the leg levelers up to provide the ultimate in strength and reliability. Great care has been taken to provide you with total comfort and safety. Golden Technologies thoroughly inspects and tests each unit prior to shipment.

! WARNING



Your Golden power lift chair is a medical device. Therefore, you are required to exercise caution when operating it to ensure your personal safety and that of others around you. The following are rules for the safe operation of your Golden power lift chair.



Care should be taken in the unpacking of this unit, so as not to cause injury to persons or damage to the unit. Dispose of all plastic bags and covers, as they can be a smothering hazard to small children.



Do not allow children or pets near the chair while the chair is operating.



Do not allow children to play with or operate the chair at any time.



Hand control should be unplugged and placed out of the reach of children when the chair is not in use.



Do not flop down into the chair when getting into it, or while it is in its lift position. Flopping down into the chair will damage it and could cause personal injury.



Do not allow anyone to sit on your lap, or on the arm of the chair, or on the footrest while in or operating the chair, as it may cause tipping and could result in personal injury.



Do not place fingers or hands between the seat cushion and the inside arm of the chair while sitting in the chair or when the chair is in operation or plugged into a power source.



Do not retrieve fallen objects from inside or under the chair while the chair is plugged into a power source.



Do not operate the chair if there are any persons, pets or other obstructions under or in front of the footrest, under the chair or behind the chair.



Do not position yourself, child and/or pet too high on the chair while the chair back is reclined. This can cause a tip over hazard. Make sure you are properly fitted for the lift chair prior to operating the chair.



Do not smoke while operating, sitting or resting in the chair.



To reduce risk of electrical shock, do not immerse any of the electrical components into a liquid, or spill any liquids onto electrical components. Do not open any of the electrical components. There are no serviceable parts.



Warranty will be void if any of the electrical components are opened by other than a qualified service person.



Make sure the chair is placed at the specified distance from a wall/corner (page 8). Failure to do so can damage the chair and will void the warranty.



Do not use any type of electrical extension cord to plug your chair into an electrical outlet. Make sure that all electrical products and their wires are positioned away from your chair as the metal lift frame mechanism could crush them and create a fire hazard and/or may cause personal injury.



Do not operate your lift chair while intoxicated or taking medications that impair your mental or physical abilities to operate the chair safely. Consult with your doctor about any medications you are taking that may affect the safe operation of the chair.



Do not operate this product if you have any medical conditions that result in limited, debilitating mental or physical capacity. You should consult your doctor before using this product.



Consult with your physician regarding using the Trendelenburg position.



Placing the lift chair in the center of a room or too far away from a wall will create a tripping hazard, because the power wires for the lift chair will be crossing main traffic areas in the residence.



Leakage from the 9 VDC backup batteries can result in property damage. Periodically inspect and replace the batteries. Read the "Battery Back Up System" and "Care and Maintenance" sections in this manual.



If the lift chair user is unconscious or sleeping the hand control may inadvertently become activated in a way that may force the user out of the chair.



Should you ever encounter a problem with the operation of your power lift chair, discontinue all use of the product upon discovery of the problem. Contact the provider from whom you purchased your chair to arrange service.



Exceeding the stated weight limit listed in this manual can result in instability of the lift chair, causing a potential tip over hazard.

Installation Of Your Power Lift Chair

Model: PR445-MED



Read before assembly.

1. Remove the transformer, hand control, and power wire from the wooden cross rail (located behind the lower outside back) by removing the white zip tie.



⚠ Place transformer on the floor behind the chair.

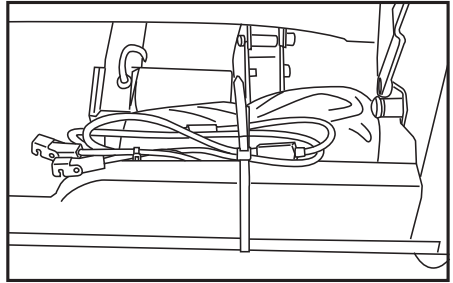

2. Place two 9 volt batteries in transformer as shown.
3. Plug the transformer into a 115-120V 60Hz A.C. outlet and connect the power cable from the chair into the transformer as shown. Make sure the power cable is routed under the wooden cross rail.

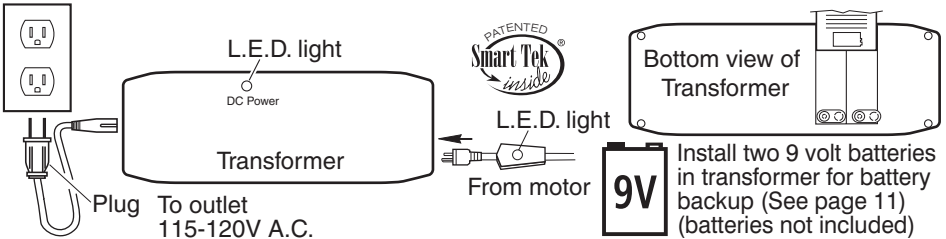

4. Align the back brackets and the seat brackets, then push down on the seat back until they are locked into place.

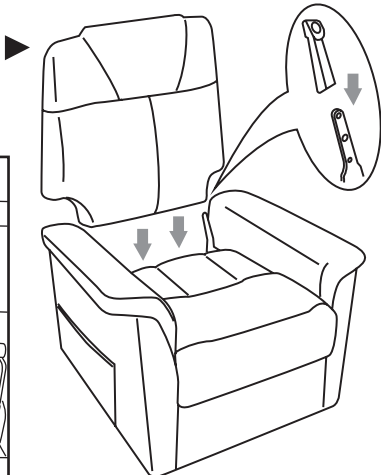

5. Connect the red and yellow connectors from the seat back to the red and yellow connectors of the chair. Red to red and yellow to yellow. Then close the locks to secure them.

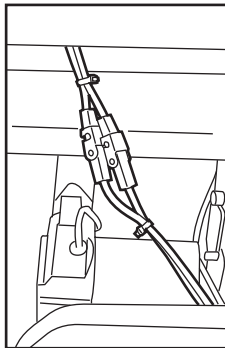

6. Reach into the pocket and attached the hand control to the extension, then close the lock to secure it.

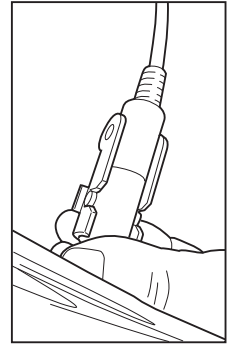

7. Recline the back of the chair to expose the zipper.

8. Zipper the back and the seat fabric together to eliminate the gap between them.

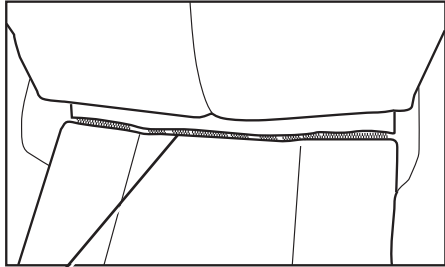

Zipper

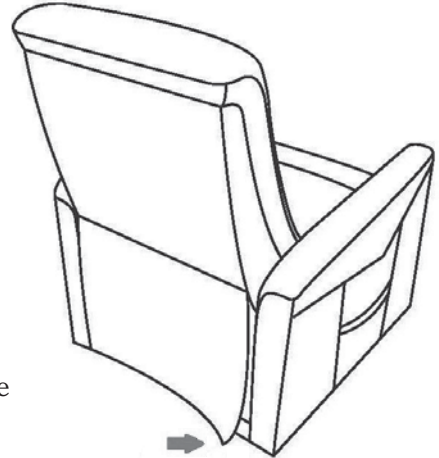

9. Attach the bottom of outside back to the Velcro on the arm cross rail.

10. Place the chair in the desired position in the room, keeping it 21" away from the wall. If placing the chair into a corner, keep it 21" from the wall as shown. See distance chart below for your model.

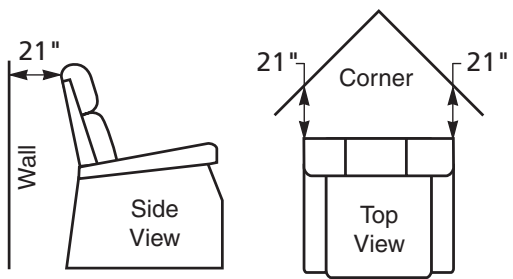

Distance Required From Wall When Reclined

Wall	Corner
21 in.	21 in.

11. Adjust the leg levelers on the bottom of the chair if necessary to level the chair. Some high pile carpets can obstruct the footrest operation by rubbing against it. Adjust the levelers to a height above the pile.

12. Secure the cord into the quick release cable clamp located above the magazine pocket on the arm of the chair.

Power Lift Chair Operation

- 1. To recline your chair**, press the down button (S2) and hold until you reach your desired position. Then release the button.
- 2. To return to a seated position from recline**, press the up button (S1) and hold until the chair returns to a closed seated position. Then release the button.
- 3. To lift your chair**, press the up button (S1) and hold until you reach your desired height. Then release the button.
- 4. To return to a seated position from lift**, press the down button (S2) and hold until the chair returns to the floor seated position. Then release the button.
- 5. To lift your chair from a reclined position**, press the up button (S1) and hold. The chair will keep going past the seated position and start to lift. Release the button when the chair reaches the desired height.
- 6. To recline your chair from the lift position**, press the down button (S2) and hold. The chair will keep going past the seated position and start to recline. Release the button when the chair reaches the desired reclined position.
- 7. Getting into your lift chair.** While standing next to your chair, press the chair up button (S1) and raise the chair to a height you can sit against. This height will vary from person to person depending on the individual's needs. Raise the chair high enough so you do not have to flop down into the chair. **Flopping down into the chair will damage it and could cause personal injury.** Press the chair down button (S2). As the chair continues downward, adjust yourself into a position that is comfortable to you. Continue pressing the button until chair is in the seated position (chair firmly on the floor), then release the button.
- 8. Getting out of your chair**, press the chair up button (S1) and raise the chair to a height that enables you to easily stand. Release the button. Return the chair to the seated position (chair firmly on the floor) after getting out of the chair so children, pets or obstructions do not get under the chair.

Power Lift Chair Operation continued

Micro Adjustments

1. To recline the back of the chair, press button (S4) and hold until the back reaches the desired position. Then release the button.
2. To bring the back of the chair to an upright position, press button (S3) and hold until the back reaches the desired position. Then release the button.
3. To raise the foot rest and seat, press button (S6) and hold until the foot rest reaches the desired position. Then release the button.
4. To lower the foot rest and seat, press button (S5) and hold until the footrest closes. Then release the button.

Note: The motors are set to shut off when they reach their fully extended or fully retracted position if the selected button is not released. If you should go past your desired position, select the button to bring you back to your desired position. You can repeat the process as often as you like.

HEADREST

1. To move the head rest out. Press button (S7) and hold it until the head rest reaches a position suitable for you, then release the button.
2. To move the head rest in. Press button (S8) and hold it until the head rest reaches a position suitable for you, then release the button.

LUMBAR

1. To move the lumbar out. Press button (S9) and hold it until the lumbar reaches a position suitable for you, then release the button.
2. To move the lumbar in. Press button (S10) and hold it until the lumbar reaches a position suitable for you, then release the button.

Note: Your Golden power lift chair can be stopped at any time during lift or recline by releasing the selected button, offering you a wide range of comfortable positions. Select the position that best suits your needs. The motor is set to shut off when it reaches its fully extended or fully retracted position if the selected button is not released. If you should go past your desired position, select the button to bring you back to your desired position. You can repeat the process as often as you like.

USB Disclaimer: The supplied USB charging port is only intended to be used with appropriate smart devices such as phones or tablets. Please refer to device manufacturer's charging requirements before using. Golden Technologies excludes liability for any damages or data loss regarding the charging device on a computer or other electronic device connected to the USB port.

1 AMP USB Charging Port

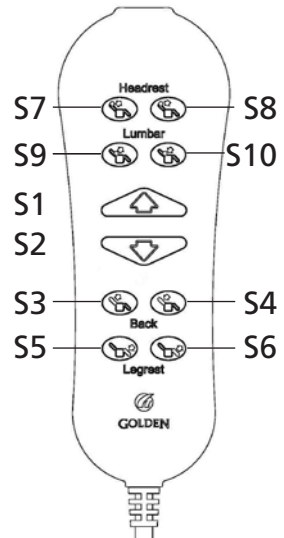

Battery Back Up System

Your Golden power lift chair comes with a battery back up system so the chair can return to the seated position in the event of a household power failure. The batteries have enough energy to bring the chair to a seated position from the recline position. *The batteries do not have enough energy nor are they intended to operate the chair for a prolonged period of time in the absence of standard household voltage (120 volt, 60 Hz).* **Batteries should be replaced after one use.** Batteries should be changed yearly. (See installation page 7.)

Smart Tek™ (Power Indication)

Your power lift chair is equipped with a backlit hand control, indicating power to the hand control.

Your power lift chair also comes with a power indicator light on the transformer and on the power cord connecting the motor to the transformer. The lights illuminate green constantly, indicating power from the outlet to the transformer and the motor. The lights have been provided to help you identify electrical disconnects, should they occur, and to help your provider to diagnose electrical problems, should they occur.

Should the chair not operate and the lights are out, check all electrical connections to the chair. Make sure everything is plugged in properly and there is power to the outlet into which the chair is plugged (see installation on page 7 for electrical connections). **Should you ever encounter a problem with the operation of your power lift chair and the lights are on, such as mechanical problems or one light is out, discontinue all use of the product upon discovery of the problem.** Contact the provider from whom you purchased your chair. They will be able to resolve problems and take care of proper factory service if needed. You will need to be prepared to answer some basic questions about your power lift chair, such as model and serial number. The model and serial number are located on the back of the hand control and the rear of the lift frame. Your provider will ask you questions about your power indicator lights, such as which one is out. Prior to calling your provider, check all the electrical connections to the chair. Make sure everything is plugged in properly and there is power to the outlet into which the chair is plugged (see installation on page 7 for electrical connections).



CONSUMER LIMITED LIFETIME AND SEVEN YEAR WARRANTY

GOLDEN, through its authorized distributor/service organization, warrants this chair to original consumer only, against defects in material or workmanship as follows:

LIFT MECHANISM, RECLINE MECHANISM AND CHAIR FRAME LIMITED WARRANTY

GOLDEN, warrants for the lifetime of the chair by the original consumer to repair or replace at Golden's option the Lift Mechanism, Chair Frame and Recline Mechanism. Labor to replace these parts is subsidized on all models for three years.

GOLDEN, shall not be responsible or obligated to pay for any cost or expense for examination of any warranted parts nor is Golden to pay for costs for transportation, handling and packaging of the parts or components.

THREE YEAR ELECTRICAL PARTS WARRANTY

GOLDEN, warrants the electrical parts of this chair against defects to original consumer only, for a period of three years from the date of original purchase by a consumer.

GOLDEN, shall not be responsible or obligated to pay for any costs or expenses for examination of any warranted parts nor is Golden to pay cost for transportation, handling and packaging of the parts or components.

ELECTRICAL PARTS LIMITED WARRANTY FOURTH THROUGH SEVENTH YEAR

During the period beginning with the expiration of the full three year parts warranty offered above and continuing through the seventh year after date of original purchase by a consumer, GOLDEN will warrant the electrical parts on the following pro-rated basis. Year 4 earns a 35% discount off suggested retail price. Year 5 earns a 25% discount. Year 6 a 15% discount and year 7 a 5% discount. By way of example, a part costing \$100.00 that needs replacement in year 4 would cost \$65.00. GOLDEN shall not be responsible or obligated to pay for any costs or expenses for examination and/or service of any warranted part or to pay for costs of transportation, handling and packaging of the chairs and/or parts or components.

TERMS APPLICABLE TO WARRANTIES

GOLDEN will, at its option, repair and/or replace the defective parts and/or components provided that the warranty parts have not been subjected to misuse, abuse or improper service by the consumer, have not been damaged in transit or handling and/or have not been altered or repaired by unauthorized representatives. This warranty does not include costs for unnecessary service calls, i.e., in-home service calls solely for the purpose of educating the consumer about the product, or finding an unsatisfactory power connection, etc. Exceeding the weight capacity of the chair will void the warranty. Fabric shading cannot be guaranteed for replacement parts or replacement chairs.

PR445-MED..... 375 lbs.

In the event that the product does not conform to this warranty at any time while this warranty is in effect, Golden will correct the defect in conformity with the Consumer Limited Lifetime and Seven Year Warranty. THE LIMITED LIFETIME AND SEVEN YEAR WARRANTY SET FORTH ABOVE IS THE SOLE AND ENTIRE WARRANTY PERTAINING TO THE PRODUCT AND IS IN LIEU OF AND EXCLUDES ALL OTHER WARRANTIES OF ANY NATURE WHATSOEVER, WHETHER EXPRESS, IMPLIED, OR ARISING BY OPERATION OF LAW INCLUDING, BUT NOT LIMITED TO ANY IMPLIED WARRANTIES OF MERCHANTABILITY OR FITNESS FOR A PARTICULAR PURPOSE. THIS WARRANTY DOES NOT COVER OR PROVIDE FOR THE REIMBURSEMENT OR PAYMENT OF INCIDENTAL OR CONSEQUENTIAL DAMAGES.

Some states do not allow this exclusion or limitation of incidental or consequential damages so the above limitation or exclusion may not apply to you.

GOLDEN shall not be liable for any incidental or consequential damages or for any other damage or loss not contained in this warranty.

This warranty gives you specific legal rights, and you may also have other rights which may vary from state to state.

All warranty claims must be approved by Golden Technologies before any service is performed.

Warranty is valid in all 50 states, Canadian Provinces and Puerto Rico.

CARE AND MAINTENANCE

Your lift chair will require routine maintenance checks. You can perform some of these checks, while others may require assistance from a provider. By following these maintenance checks, you can make sure your lift chair gives you years of trouble-free operation. If you have any questions or concerns regarding your lift chair's care and maintenance, contact your provider.

- ✓ Before cleaning your lift chair, consult your provider for the proper types of cleaner and cleaning methods.
- ✓ Keep all electrical components free from moisture and liquid spills. **Intended for indoor use only.**
- ✓ Periodically inspect all wiring harnesses to make sure they are not cut, damaged, frayed, or disconnected. If damage of any type is present, unplug the lift chair and contact your provider.
- ✓ Periodically check all fasteners for tightness, wear, and corrosion. If any of these are present, unplug the lift chair and contact your provider.



Warning: Be careful of pinch points and sharp metal parts (wear gloves).

- ✓ Replace the batteries after one use. Replace the batteries yearly, even if they were not used. **Batteries are intended for one use only!**

NOTES

NOTES

NOTES



GOLDEN PRODUCT REGISTRATION

Register Now To Lock In Your Warranty and Receive Important Product Updates

SAVE TIME - REGISTER ONLINE: WWW.GOLDENTECH.COM

SERIAL NUMBER

*Most Lift Chairs Have On Controller Wire or Back Rail of the Metal Frame
Most Scooters & Powerchairs On Seat Post, Under/On Battery, or Under Carpet*

PRODUCT MODEL NUMBER

*Most Lift Chairs Start with PR (PR401, PR510, etc).
Most Scooters with G (GA, GB, GC, GL, GR, etc) Most Powerchairs with GP*

PURCHASE DATE

FIRST NAME

LAST NAME

ADDRESS

ADDRESS LINE 2

CITY

STATE / PROVINCE ZIP / POSTAL CODE

E-MAIL ADDRESS

PROVIDER NAME

PROVIDER'S ADDRESS

ADDRESS LINE 2

CITY

STATE / PROVINCE

ZIP / POSTAL CODE

COUNTRY

Product comments:

Rate Provider Experience (Circle One - 1 Bad, 5 Great)

1 2 3 4 5



PLACE
STAMP
HERE



GOLDEN TECHNOLOGIES
401 BRIDGE ST
OLD FORGE PA 18518-2323



Inquire about these fine mobility products also available from Golden Technologies



If you're looking for the perfect portable scooter loaded with style, look no further than the Buzzaround XL! Featuring a 300 lb. weight capacity, the Buzzaround XL disassembles quickly and easily.



Nothing beats the luxury of the Golden Companion scooter line! The Companions feature our patented adjustable tiller, bright head and tail lights and a plush seat. Weight capacities of 350 and 400 lbs.



The Golden Compass Sport power chair is the ideal power chair for consumers looking for tight indoor space maneuverability with a patented springless articulating chassis and true center wheel drive technology to traverse the great outdoors.



FOR YOUR RECORDS

Please fill in your Power Lift & Recline Chair information below. This information will be useful in the event that you should ever need to contact Golden Technologies, Inc. concerning your lift chair.

Date of Purchase _____

Model _____

Serial Number _____

Your Golden Technologies, Inc. representative or provider

Name _____

Company _____

Address _____



WARNING



Do not allow children to play on this mechanized furniture or operate the mechanism.

Leg rest folds down on closing so that a child could possibly be injured.

Always leave chair in a sitting position. Keep hands and feet clear of mechanism. Only the occupant should operate it.

