



Luggie[®]

SMART TRAVELERS NEED SMART TRAVEL SOLUTIONS

FreeRider designs and manufactures mobility scooters in Taiwan with the use of only the finest materials. We were the first folding mobility scooter designer and maker in the world. We named it Luggie!

Luggie is more than a mobility scooter, you can count on it to be the best ride you've ever had.

V 2020

FR
FREERIDER

WHY LUGGIE?

What you need to know before you buy any travel scooter.

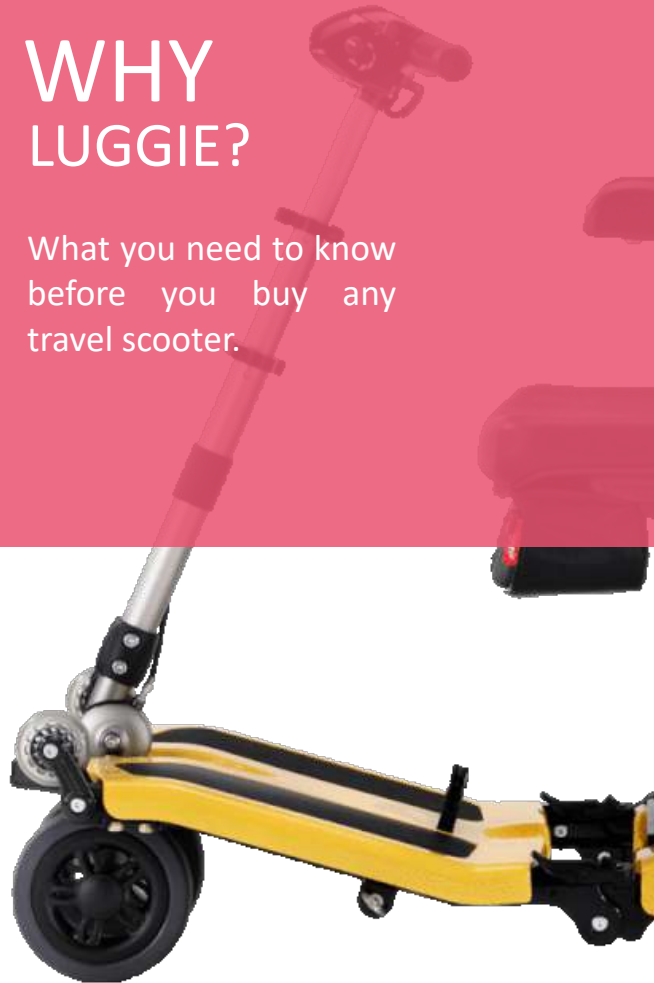

Why customers choose Luggie as a travel scooter?

Everyday there are hundreds of riders around the world, that choose Luggie as their 1st travel scooter. We accumulate thousands of loyal customers each year.

01 Space

- Smallest Footprint
- Smallest Turning Radius

02 Efficiency

- Quickest Charging
- Highest mile per Ah

03 Safety

- Safe to ride
- Safe to ship

01 Space

Why you need special features?

- Spacious legroom but smallest footprint
- Smallest Turning radius*

BENEFITS

A

Ideal travel scooters are convenient to carry and convenient to store. When you travel, most spaces are limited such as restaurants, or elevators, a small turning radius helps to **move freely** in any constrained space.

*Luggie Plus 4 comes with the smallest turning radius compared to other 4-wheel scooter class. Turning radius of Luggie Plus 4 is 36" which is the smallest turning radius in the market.



Lift your scooter into your trunk without a lifting device and save the trunk space.

L
U
G
G
I
E

**FOLDING
VARIATOIN**





Quick Fold Mold

Place your top console between your seat back and the seat to store it in your trunk quickly.

Flat Fold Mold

Secure your top console under your seat while you check-in at the airport or use our travel storage bag.





Upright

without moving seat or adding a bumper kit.

02 Efficiency

Why you need efficient features?

- Quickest charging
- Highest mile per Ah

BENEFITS

A

Battery anxiety is the most common issues when you are using an electronic device, especially during travel. Thanks to our SuperCharger, the 8.5ah lithium-ion battery can be fully **charged within 90 minutes**, just one meal time. Our highest efficient powertrain gives you the longest range with the same battery capacity.

Shortest charging time; Longest riding range.

LUGGIE Li-ion Guide

11 MILES

8.5 AH

Powered by 18650 Li-ion battery pack with certified IEC 62133 and UN 38.3. In addition, it adopts intelligent BMS battery management system which comes with various battery protections for the battery cell and your safety.

0~85% charge in 60-min and offers you up to 8-miles.



MSRP 799

15 MILES

10.5 AH

Powered by 18650 Li-ion battery pack with certified IEC 62133 and UN 38.3. In addition, it adopts intelligent BMS battery management system which comes with various battery protections for the battery cell and your safety.

0~85% charging in 85-min and offer you up to 10-mile

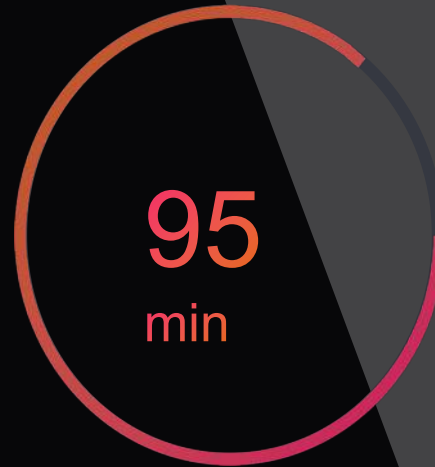

MSRP 999

22 MILES

16.5AH

Powered by 18650 Li-ion battery pack with certified IEC 62133 and UN 38.3. In addition, it adopts intelligent BMS battery management system which comes with various battery protections for the battery cell and your safety.

0~85% charging in 170-min and offer you up to 18-mile

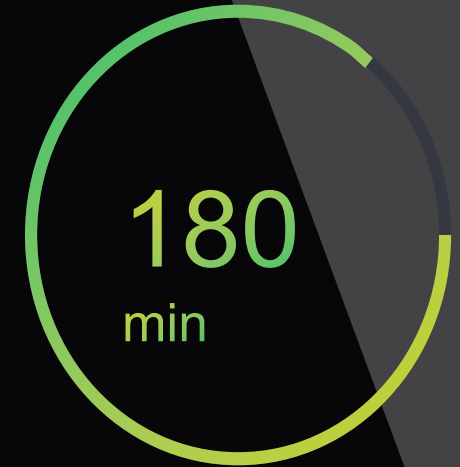

MSRP 1299



Home Docking Station

Home Docking Station is one of our most popular accessories used to charge your battery while detached from your scooter. You can leave your scooter in garage and charge your battery in your living room.

SuperCharger

SuperCharger gives a 5A output so your charging time is shorter than others.

Not available in the Luggie Classic series



03 Safety

Why you need safety features?

- Safe to use
- Safe to ship

BENEFITS

A

Most mobility scooters are equipped for seniors and disabled people. Mobility scooters act as their feet to get around. Therefore, safety is important. FDA regulations ensure every consumers' right to avoid the risk of using unqualified mobility devices.

The K number is a Medical Devices ID which is required for a manufactures' product to pass all the testing criteria.

The Luggie Line is an **FDA Approved**, non recreational product.

Zero-Worry Mobility Scooter

ZERO

Zero-Welding: The whole frame has adopted T6061 aluminum alloy which is commonly used in aircraft material. A forging process to enhance its capabilities.

Zero-barrier: No barrier in the front chassis design perfect for outdoor terrain.

Zero-Lifter: Folding Variation supports LEVERAGING the scooter without lifter or ramp, saves costs and space.

Zero- battery upgrade: Luggie can use all Luggie lithium-ion battery series.

Classic model requires an adaptor

Forged Aluminum

LUGGIE scooters are made of aerospace grade aluminum which process is **forged aluminum**.

For LUGGIE, it means the chassis of our extremely light, and durable, also react elastically under higher capacity and yield, so it is capable to make a highly compact very heavy duty scooter.

As the first company to design and manufacture forged aluminum alloy chassis, we take our production standards very seriously.

This magnificent material and production process make our folding scooter **durable, lightweight, and compact**.

Features of forged aluminum alloy

Function

- Higher Strength
- Better Stiffness
- Design Oriented
- Better Durability
- Higher Elongation
- Higher Impact resistance

Material

- Higher material yield and fracture
- Better material flow texture
- Tighter microstructure

Finishing

- No surface pinhole
- Ultra-bright radiance

Weight

- Better steering
- Less mass and better fuel economic

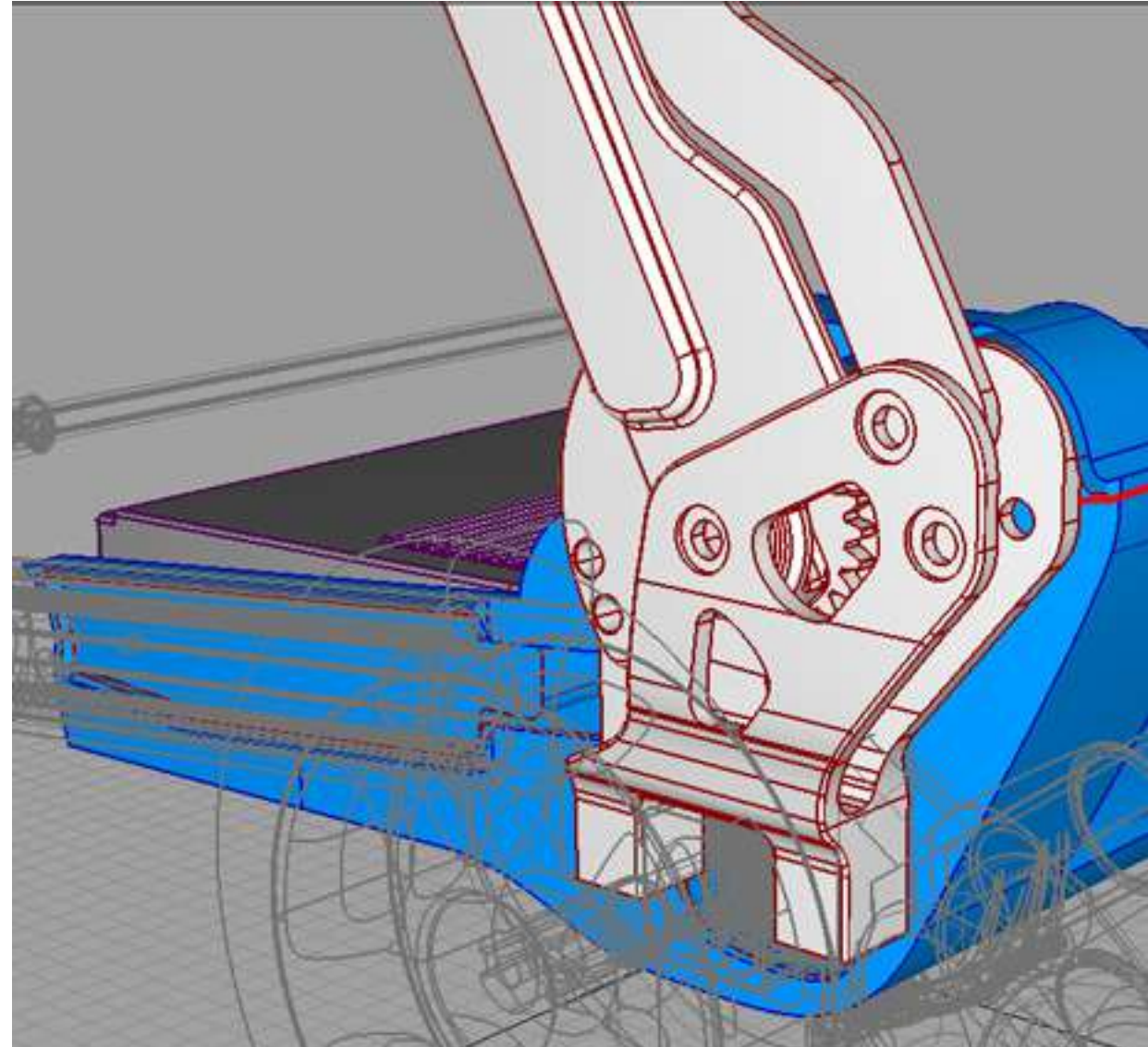

Values



EFFICACY

Aircraft aluminium class for our chassis, with zero-welding technique to make the strongest chassis compared to other power chair suppliers. It has the **smallest footprint and largest weight capacity** of all folding power chairs in the world.

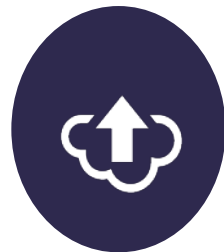

UPGRADABLE

We have different lithium-ion **battery options** to meet your different requirements: 8.5ah, 10.5ah, and 16.5ah. You can choose a larger capacity if you have a long journey.



MEDICAL DEVICE

Luggie Scooter is certified with all the mobility scooter requirements, it comes with a K number based on FDA regulations. We submitted it as a **Medical Device** to ensure your riding safety and is backed with product liability insurance.



WARRANTY

Lithium-ion batteries are the most common in portable power supply. However, we are the only one to provide a **12-month warranty** instead of the standard 6 month warranty from others.

International testing criteria for lithium batteries, or equipment containing lithium batteries undergo strict testing criteria.

UN 38.3

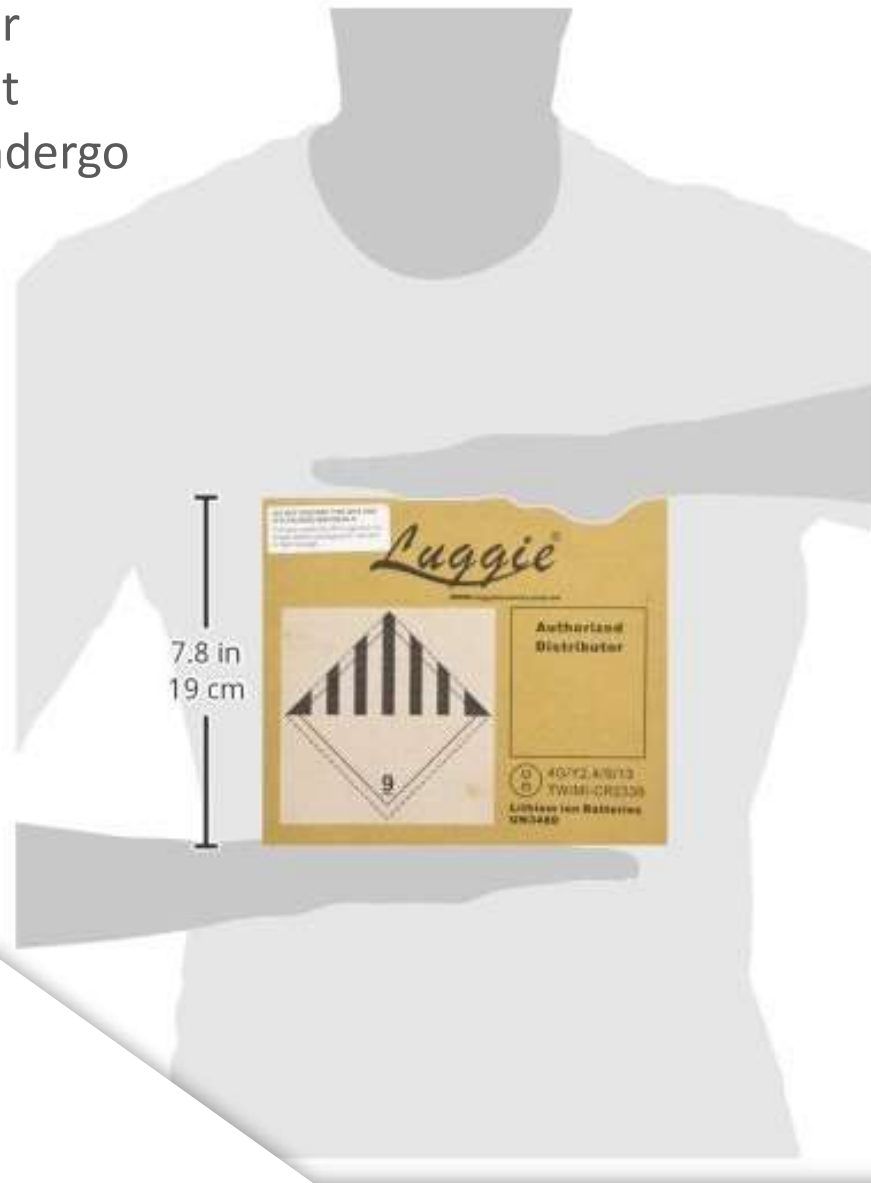

All of our lithium-ion batteries are certified with UN 38.3 criteria. The Batteries weight is 4.5lbs.

Customers can carry the light weight battery through the airport. It is **TSA approved.**



Luggie Series Intro

Classic

Classic is the entry level scooter of Luggie, its uses a pair of 12ah AGM batteries. The adaptor can be used to upgrade to li-ion battery directly. It comes in two editions: 250lbs and 320lbs for different user demands.

C

Standard

Equipped with armrest and the weight capacity is 250lbs. You can build your own battery options in 2020.

S_d

Elite

Extendable handle and 16" seat width. The top console comes with reverse alarm in 2020.

E

Super

A long wheelbase and wide track add up to space, stability and sportiness. Luggie Super is the ideal balance of athleticism and elegance.

S_P

Luggie Lineup

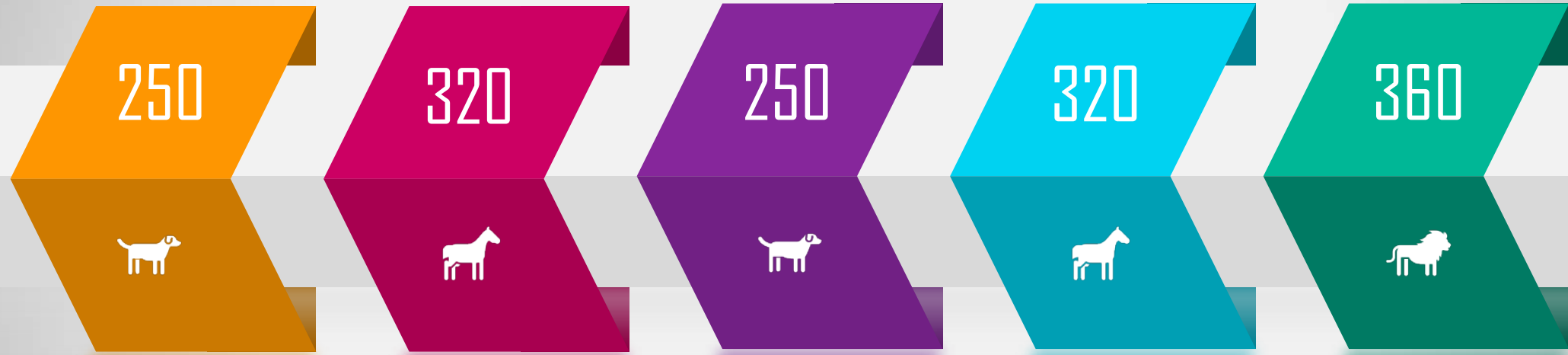

Classic

- 10 mile \$1999
- 15 mile \$2149
- 22 mile \$2699

Classic II

- 10 mile \$2399
- 15 mile \$2599
- 22 mile \$2899

Standard

- 10 mile \$2199
- 15 mile \$2399
- 22 mile \$2599

Elite

- 10 mile \$2599
- 15 mile \$2799
- 22 mile \$2999

Super

- 10 mile \$2999
- 15 mile \$3099
- 22 mile \$3199

Model	Classic	Standard	Classic II	Elite	Super
Weight Cap/ lbs	250	250	320	320	360
Length / inch	39	39	39	39	39
Width / inch	18	18	18	18	20
Top Speed /mph	4	4	4	4	4
Scooter Weight / lbs (w/o battery, armrest)	50	50	50	50	60
Range / (up to miles)	22	22	22	22	22
Turning Radius/ inch	40	40	40	40	41
Ground Clearance at side-deck / inch	4.5	4.5	4.5	4.5	4.5
Batter indicator	Needle	Needle	Needle	LED	LED
Seat Width/ inch	15	15	15	16	17
Handle Type	Standard T bar	Standard T bar	Standard T bar	Extendable T bar	Extended T bar
W/Armrest	Optional	Yes	Optional	Yes	Yes
Reverse alarm	-	-	-	Yes	Yes

Multi-Wheel Structure

Multi-wheel structure is more stable and reliable than single wheel. It's has been used in the aerospace industry and even the wheel in your travel luggage.







Wider Wheel Track

Available to Luggie Super Series

Standard Wheel Track

Available to Luggie Classic,
Standard and Elite



Super

vs

Standard





Omni-Suspension

Available to Luggie Plus 3

No Suspension

Available to entire Luggie





Foldable basket

Put your accessories under your seat.

Travel Storage Bag

Protect your scooter while you check-in to airport or storage your scooter in your garage.





2020

JOIN US

FREERIDER USA
8696 Utica Ave Rancho Cucamonga, CA 91730
Email: sales@freeriderusa.com
TEL: 909-466-7996
FAX: 909-466-7990