

Owner's Manual



▶ Power Chair P318

Table of Contents

Introduction

Indications For Use	2
Quantity of Contents	2
Device Description	3
Practice Before Operating	4

Safety Instructions

Safety Considerations	6
Driving Outdoors	10
Driving on Various Terrains	12

Familiarize Yourself With Your Powerbase Wheelchair

Feature Diagram	14
Specification	15
Terminology	16
Seat Removal	17
Shroud Removal	18
Attach Shroud	19
Remove Battery	21

Operating Your Powerbase Wheelchair

Seat Height Adjustment	22
Armrest Width/Height Adjustment	22
Armrest Angle Adjustment	23
Footrest Angle Adjustment	23
Headrest Height Adjustment	23
Joystick Position Adjustment	23
Manual Freewheel Levers	24
VR2 Controller Operation	25
Batteries and Charging	30

Care And Maintenance

Daily Checks \ WEEKLY CHECKS	34
Monthly Checks \ YEARLY CHECKS	35
Wheel Replacement	36
Wiring Harnesses	37
Part Lists	39
Wiring Diagram	40

Rec Symbols

Warranty

Limited Warranty	42
------------------	----

Troubleshooting Tips

Welcome aboard your new powerbase wheelchair, and thank you for choosing our product. Please read this manual carefully, and follow all instructions before attempting to operate your powerbase wheelchair for the first time. If there is anything in this manual that you do not understand, or if you require additional assistance for setting up your powerbase wheelchair, please contact your local dealer.

This latest model is designed for specific practical user needs, combining solid, rugged construction, and modern high-tech electronics, to enhance safety and performance.

With a state-of-the-art, programmable electronic control system, your powerbase wheelchair can be programmed and adjusted within a given range of its performance characteristics, to suit your individual needs. The controller is set up at the factory to give the powerbase wheelchair nominal operating performance characteristics.

After becoming familiar with the basic operation of the powerbase wheelchair, you may wish to customize the settings to fit your own personal preferences. A wide range of customization options can be adjusted such as acceleration, deceleration, maximum speed, turning speed, safety controls, better maneuverability of the joystick, and so on. Contact your local dealer for advice on additional equipment you may need.

Having your powerbase wheelchair checked regularly by your local dealer is the best way to ensure smooth operation, and safety.

This manual provides users practical tips and information on safety issues, operation, and maintenance. Please read it very carefully to ensure your maximum enjoyment and to fully benefit from your independence and mobility.

Whenever special advice or attention is needed, please do not hesitate to contact your local dealer, who has the tools and know-how to provide expert servicing for your powerbase wheelchair.

Your satisfaction and opinions are highly valued by both your local dealer and our company. Please be sure to fill out the enclosed guarantee form, and return it to your local dealer. The information is necessary for providing you with the best service, and to be sure all of your needs are met.

■ Indications For Use

The Merits Model P318 Powered Wheelchair is to provide mobility to persons limited to a seated position that are capable of operating a powered wheelchair.

 **Cautions** Federal law restricts this device to sale by or on the order of a physician.

■ Quantity of Contents

The device is in one package: The quantity of contents are as following:

Device Package

Item	Component	Quantity	Note(Sold separately)
1	Power Base	1	
2	Joystick	1	V
3	Charger	1	V
4	Power cord	1	V
5	Owner's manual	1	
6	Battery connecting wire	2	V
7	Tool kit	1	V
8	Seat	1	V
7	Armrest Ass'y. L/R	1L/1R	V

■ Device Description

Model P318 Powered Wheelchair is battery powered, front wheel motor driven and is controlled by the PG power wheelchair VR-2 50amp controller. The user interface is a joystick. P318 is powered by two 12 VDC 34ah (U1) batteries. The batteries are charged by a 4A off-board charger connected with 3-pin Microphone Connector to the charging socket on the joystick. The approximate driving range on fully charged batteries is up to 28km (18mi). The chair frame is a riveted nut and welded steel construction and includes two front drive wheels with drive units (including motor, gear, brake), batteries and rear pivoting casters. Depending on users needs, the joystick motor control is mounted to the left or right armrest. When the user activates the joystick, the controller receives a signal to release the brakes. With the brakes released, the wheelchair is allowed to move in the direction the joystick is actuated. When the user releases the joystick, the chair slows to a stop and the brakes are automatically re-engaged. The solenoid electromechanical brakes allow the user to stop by letting go of the joystick.

The upholstery of the device complies with EN 1021-1/-2:2006: Furniture: Assessment of the ignitability of upholstered furniture: Ignition source: Smouldering cigarette/ Match flame equivalent

The device can be operated on dry, level surfaces composed of concrete, blacktop, or asphalt under normal driving conditions.

Failure to follow these instructions may result in damage to the powerbase wheelchair or serious injury.

■ Practice Before Operating

Find an open area such as a park and have an assistant to help you practice until you have confidence operating this vehicle.

Make sure that the power is off before getting in or out of the seat. Set the speed control button according to your driving ability.

We recommend that you keep the speed control at the slowest position until you are familiar with the driving characteristics of this vehicle.

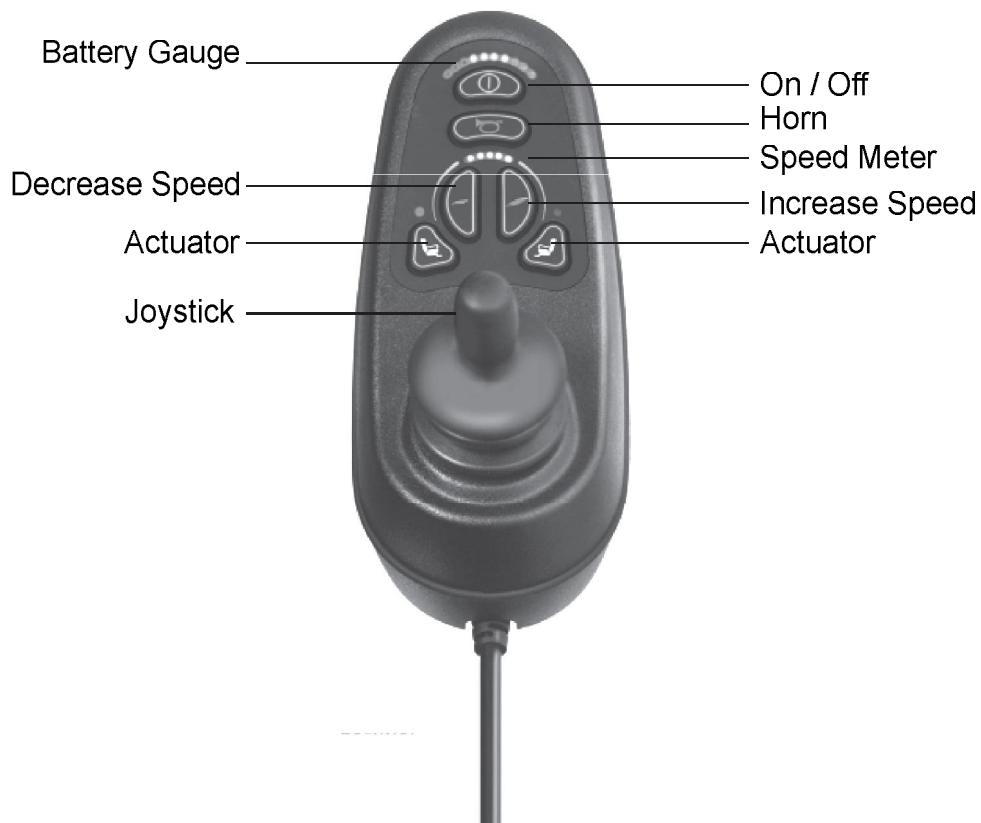

! SAFETY WARNING

YOUR AUTHORIZED DEALER, PROVIDER, THERAPIST(S), AND/OR OTHER HEALTHCARE PROFESSIONALS ARE RESPONSIBLE FOR DETERMINING YOUR REQUIREMENT FOR A SEAT BELT FOR SAFE OPERATION OF YOUR MOBILITY DEVICE. REQUIRING A SEAT BELT TO SAFELY OPERATE YOUR MOBILITY PRODUCT, MAKE SURE IT IS FASTENED SECURELY IN ORDER TO REDUCE THE POSSIBILITY OF A FALL FROM THE MOBILITY PRODUCT.

Getting familiar with this vehicle



**First, practice moving forward.
Be sure to set the speed to the lowest setting.**

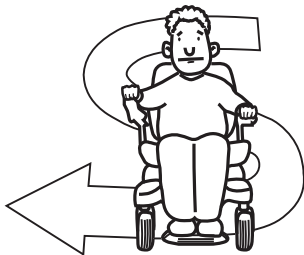

**After becoming familiar with moving forward,
practice making "S" turns.**



**Once you are familiar with "S" turns, practice
moving in reverse. Note that at any speed
control setting, the vehicle moves more slowly in
reverse than forward**

■ Safety Considerations

DO NOT do any of the following



NO!

Do not carry any passengers



NO!

Do not drive across a slope



NO!

Do not drink and drive
Consult your physician to
determine if your medications
impair your ability to control this
vehicle



NO!

Do not tow a trailer



NO!

Do not turn on or use hand-held personal
communication devices such as citizens band(CB)
radios and cellular phones

 **Warnings**

- **DO NOT** use an escalator to move a wheelchair between floors. Serious bodily injury may occur.
- **DO NOT** lean over the top of the back upholstery to reach objects from behind as this may cause the wheelchair to tip over.
- **DO NOT** shift your weight or sitting position toward the direction you are reaching as the wheelchair may tip over backwards or sideways.
- **DO NOT** tip or wheel the wheelchair without assistance, unless you are highly skilled.
- **DO NOT** attempt to stop a moving wheelchair with wheel locks. Wheel locks are not brakes.
- **DO NOT** stand on the frame of the wheelchair.
- **ALWAYS** use caution when transferring in or out of the wheelchair. Every precaution should be taken to reduce the transfer distance. Also be certain the wheel locks are engaged to prevent the wheels from moving.

 **Cautions**

- Riding over curbs or obstacles can cause tipping and serious bodily harm. If you have any doubt that you can safely cross any curb or obstacle, **ALWAYS ASK FOR HELP**. Be aware of your riding skills and personal limitations. Develop new skills only with the help of a companion.
- The wheelchair is not designed for weight training and is unsafe for use as a seat while weight training. Weight training from the wheelchair substantially changes the stability of the chair and may cause tipping.

■ EMC

This vehicle has an immunity level of 30 v/m which should protect it from Electromagnetic Interference(EMI) from radio wave sources. The rapid development of electronics, especially in the area of communications, has saturated our environment with electromagnetic (radio) waves that are emitted by television, radio and communication signals. These EM waves are invisible and their strength increases as one approaches the source. All electrical conductors act as antennas to the EM signals and, to varying degrees, all power wheelchairs and power scooters are susceptible to electromagnetic interference (EMI). This interference could result in abnormal, unintentional movement and/or erratic control of the vehicle.

Powered wheelchairs and electric power scooters (in this text, both will be referred to as powered wheelchairs) may be susceptible to electromagnetic interference (EMI), which is interfering electromagnetic energy emitted from sources such as radio stations, TV stations, amateur radio (HAM) transmitters, two-way radios and cellular phones. The interference (from radio wave sources) can cause the powered wheelchair to release its brakes, move by itself or move in unintended directions. It can also permanently damage the powered wheelchair's control system. The intensity of the EM energy can be measured in volts per meter(V/m). Each powered wheelchair can resist EMI up to a certain intensity. This is called the "immunity level." The higher the immunity level, the greater the protection. At this time, current technology is capable of providing at least 30 V/m of immunity level which would provide useful protection against common sources of radiated EMI.

Following the warnings listed below should reduce the chance of unintended brake release or powered wheelchair movement that could result in serious injury:

- 1) Do not turn on hand-held personal communication devices such as citizens band (CB) radios and cellular phones while the powered wheelchair is turned on.
- 2) Be aware of nearby transmitters such as radio or TV stations and try to avoid coming close to them.

- 3) If unintended movement or brake release occurs, turn the powered wheelchair off as soon as it is safe to do so.
- 4) Be aware that adding accessories or components, or modifying the powered wheelchair, may make it more susceptible to interference from radio wave sources. (Note: there is no easy way to evaluate their effect on the overall immunity of the powered wheelchair).
- 5) Report all incidents of unintended movement or brake release to the powered wheelchair manufacturer, and note whether there is a radio wave source nearby.

Warning: The wheelchair might disturb the operation of devices in its environment that emit electromagnetic fields (e.g. alarm systems of shops, automatic doors)

TURN OFF YOUR POWER WHEELCHAIR AS SOON AS POSSIBLE WHEN EXPERIENCING ANY OF THE FOLLOWEING:

1. Unintentional motions.
2. Unintended or uncontrollable direction.
3. Unexpected brake release.

The FDA has written to the manufacturers of power wheelchairs, asking them to test their new products to be sure they provide a reasonable degree of immunity against EMI. The letter says that powered wheelchairs should have an immunity level of at least 30 V/m, which provide a reasonable degree of protection against the more common sources of EMI. The higher the level, the greater the protection.

■ Driving Outdoors

When you are on the road, please pay attention to the following:

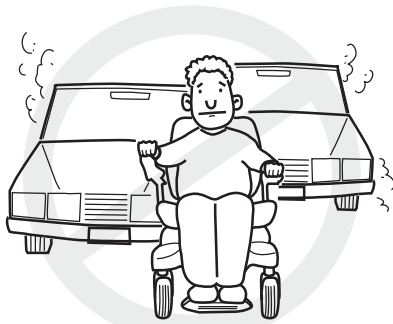

NO!

Do not drive in traffic.



NO!

Do not drive beside a river, port, or lake without a fence or railing.



NO!

If possible, do not drive during the rain.



NO!

If possible, do not drive during or on snow.



NO!

Do not drive off-road or on any uneven surfaced roads.



NO!

If possible, do not drive at night.

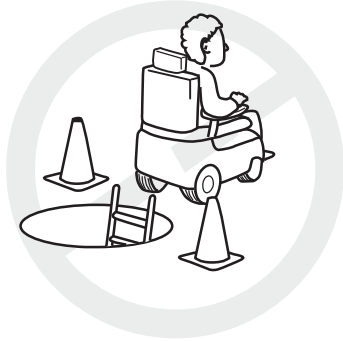

DO!

Make sure that there are no obstacles behind you when in reverse.

We recommend to set the speed at the lowest setting for reversing.



NO!

Do not make sudden stops, weave erratically, or make sharp turns.



DO!

Keep your arms on or inside the armrests and feet on the footrest at all times.



NO!

Do not attempt to climb curbs greater than $1\frac{1}{2}$ " (4cm).

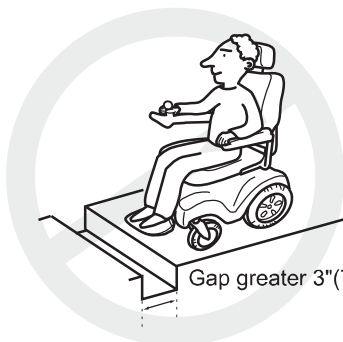

NO!

Do not attempt to cross over a gap greater than 3" (7.5cm).

Gap greater 3" (7.5cm)

■ Driving on Various Terrains

Driving on hills is more dangerous than on level surfaces. If you fail to heed these warnings, a fall, tip-over or loss of control may occur and cause severe injury to the vehicle user or others.



NO!

Do not attempt to climb a hill greater than 6°



NO!

Do not reverse while driving up a hill.

Forward only. If you reverse while moving up a hill, it may cause the vehicle to tip over.



NO!

Do not attempt to drive across a sloping surface greater than 3°

Driving across a slope greater than 3° is very dangerous and may cause the vehicle to tip over.



NO!

Do not drive over soft, uneven or unprotected surfaces such as grass, gravel and decks.

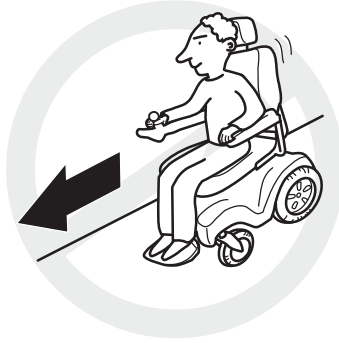

DO!

Use low speed while driving down hill.

When braking while moving down hill, the wheelchair will take longer to come to a complete stop.



NO!

Do not get on and off on a hill.

Always stop on the level surface to get in and get out of the vehicle.



YES!

Always climb or descend gradients perpendicular to the slope or ramp.

model: Electrically Powered Wheelchair P318
maximum user weight 136Kg

Year of production:

SN:



#merits

Protect against splashing water:IPX4

MERITS HEALTH PRODUCTS CO., LTD.

No. 18, Jingke Road, T.P.M. T Park, Nantun District,
Taichung City 40852, Taiwan, R.O.C.

Made In Taiwan

Familiarize yourself with your powerbase wheelchair

■ Feature Diagram

In this section, we will acquaint you with the many features of your powerbase wheelchair and how they work. Upon receipt of your powerbase wheelchair, inspect it for any damage. Your powerbase wheelchair consists of the following components.



■ Micro Compact Powerbase Wheelchair Specifications



Mode No.	P318
Length	84.7cm/33.4"
Width	60.6cm/23.9"
Seat Width	18"
Seat Height (from ground)	51cm~56.1cm/ 20.1"~22.1"
Seat Height (from deck)	42cm~47.1cm/ 16.5"~18.5"
Speed	6.4kph/4mph
Range up to	28km/18mi
Weight Capacity	136kg/300lbs
Base Weight	28.5kg/62.7lb
Seat Weight	17.4kg/34.8lb
Battery Weight/ea	12kg/26lb
Motor	DC24V/130W
Brake	Intelligent regenerative electromagnetic brake
Controller	PG nVR2 50A
Battery	12V U1*2pcs
Charger	4A off-board
Gradient	6°(300lbs)
Caster Wheel	6" PU tire
Drive Wheel	9" PU tire
Recommended Storage and Shipping Temperature	Dry (15%~95% Non-Condensing), Well ventilated area -20°C ~ 60°C (-4°F ~ 140°F) Without batteries

■ Terminology

Joystick: The device used to "move" the powerbase wheelchair.

Controller: The device that allow joysticks to function. Not all joysticks have a controller.

Armrests: Where arms can rest during time spent on powerbase wheelchair.

Footrest: Where feet rest during time spent on the powerbase wheelchair.

Drive Wheel: The wheels that move the powerbase wheelchair. These are the main wheels.

Caster Wheel: the rear wheels.

Controller Harness : Cable connecting the joystick to the controler.

Freewheel Lever: For convenience, your powerbase wheelchair is equipped with freewheel levers. These levers allow you to disengage the drive motors and maneuver the chair manually.

Type B applied parts: seat, armrest, foot plate, joystick module.

Classification: Internal powered equipment by 24 VDC, Class II in charging mode.

Mains connection of battery charger: 100-120 VAC, 50/60 Hz.

Braking information: 1) Running brake: Your electrical wheelchair is equipped with electromagnetic and regenerative brakes. Uses electricity to rapidly slow the wheelchair when the joystick returns to the center/stop position and acts as a parking brake.

2) Parking brake: when the joystick is in center position acts as an electromagnetic brake. In freewheel mode an assistant has is in to operate the parking brake by engaging the drive system again. No battery power is necessary for this function.



WARNING: DO NOT use the powerbase wheelchair without the presence of an attendant while the drive motors are disengaged! **DO NOT** disengage the drive motors when your powerbase wheelchair is on an incline, as the chair could roll down on its own, causing injury!

To engage or disengage the drive motors:

1. Locate the lever on the top of the power base.
2. Push both levers forward away from the seat post to engage the drive motors (drive mode).
3. Pull both lever rearward toward the seat post to disengage the drive motors (freewheel mode).

■ Disassembly of the Powerbase wheelchair

Seat Removal:

- (1) Disconnect the controller plug. (Fig A)
- (2) Turn the seat lock-handle up. (Fig B)
- (3) Lift seat up. (Fig C)

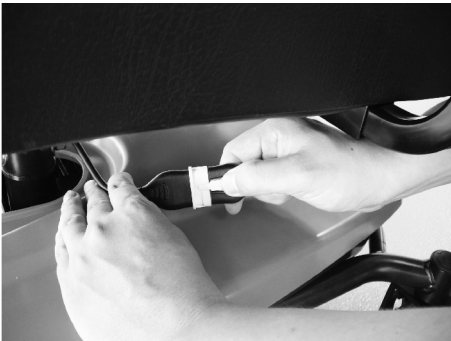

Fig A



Fig B



Fig C

Shroud Removal



Fig D1

1. Use two hands to hold the rear end of the shroud. Slightly pull up the rear end of the shroud. This will release the rear hooks from the bracket at the battery tray.(Fig D1)



Fig D2

2. Holding it the same pull the shroud up, this will release the the front hooks from the bracket at the front frame. (Fig D2)



Fig D3

3. After both hooks are released from the front frame and rear battery tray, it can be removed from the base unit. (Fig D3)

Attach Shroud



Fig D4

1. Please note there are two hooks at the front end of shroud for matching with the front frame. (one for each LH and RH) (Fig D4)



Fig D5

2. Please note there are two hooks at the rear end of shroud for matching with the battery tray. (one for each LH and RH). (Fig D5)



Fig D6

3. Use two hands to hold the front end and rear end of the shroud. Align the hole at the shroud center with the seat post. (Fig D6)



Fig D7

4. Slightly lean down the front end of shroud. This will make the seat post go through the hole at the shroud center. (Fig D7)



Fig D8

5. Make sure the shroud front end touches the front frame and then slightly move the shroud from rear to front. This will make the front hooks attach to the bracket at the frame. (Fig D8)

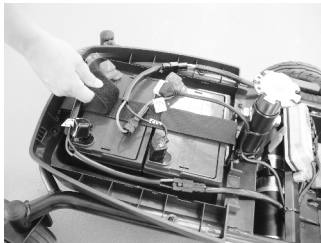

Fig D9

6. Push the rear end of the shroud. This will make the rear shroud hooks attach to the bracket at the battery tray. (Fig D9)

Remove Battery:

- (1) Remove shroud.
- (2) Take apart the reusable fastener. (Fig E1)
- (3) Disconnect the battery wire. (Fig E2)
- (4) Take off the batteries. (Fig E3)



(Fig E1)

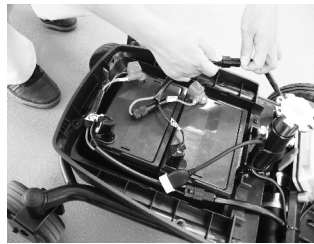

(Fig E2)

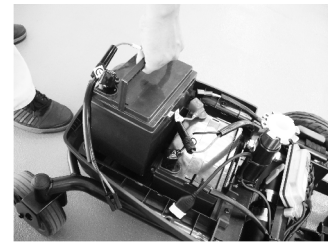

(Fig E3)

Seat Height Adjustment:

- (1) Hold hexagonal bolt with a 17mm wrench and loosen the nut. (Fig F)
- (2) Choose the right height and Tighten the bolt



(Fig F)

Armrest width / height Adjustment:



Fig G1



Fig G2

(1) Width adjustment. (Fig G1)

Loosen the set screw with allen key and adjust to the right width, then tighten the set screw.

(2) Height adjustment. (Fig G2)

Loosen the knob and adjust the armrest to right height then tighten knob.

Armrest Angle Adjustment:

1. Flip up the armrest for easy access.
2. Turn the set screw counter-clockwise to raise the armrest and clockwise to lower the front of armrest (Fig. H).



Fig H

Footrest Angle Adjustment:

1. Flip-up the footplate for easy access (Fig. I).
2. With an Allen wrench, simply turn the bolt clockwise to increase the angle or counter-clockwise to decrease it (Fig.I).
 - (1) Hold hexagonal bolt (RH) with wrench and loosen the nut (LH). (Fig I)
 - (2) Choose the right angle and tighten the bolt.



Fig I

Headrest Height Adjustment:

Depress then release the clamp on the left of backrest while pulling headrest up or pushing down until you reach the desired comfort position (one of three). (Fig J)



Fig J

Joystick Position Adjustment:

Loosen the set screw with allen key and adjust the joystick bar to right position. then tighten. (Fig K)



Fig K

■ Manual Freewheel Levers:

The powerbase wheelchair has a manual freewheel lever on each motor. Manual freewheel levers enable you to disengage the drive motors from the gearboxes and maneuver the chair manually.



WARNING! Do not use the powerbase wheelchair while the drive motors are disengaged! Do not disengage the drive motors when the powerbase wheelchair is on an incline, as the unit could roll on its own, causing injury!

To engage or disengage the drive motors:

1. Locate the lever on the top of the power base.
2. Push both lever forward away from the seat post to engage the drive motors (drive mode). (Fig L1)
3. Pull both lever rearward toward the seat post to disengage the drive motors (freewheel mode). (Fig L2)

If a lever is difficult to move in either direction, slightly rock the powerbase wheelchair back and forth. The lever should then move to the desired position.



WARNING! It is important to remember that when your powerbase wheelchair is in freewheel mode, the braking system is disengaged.

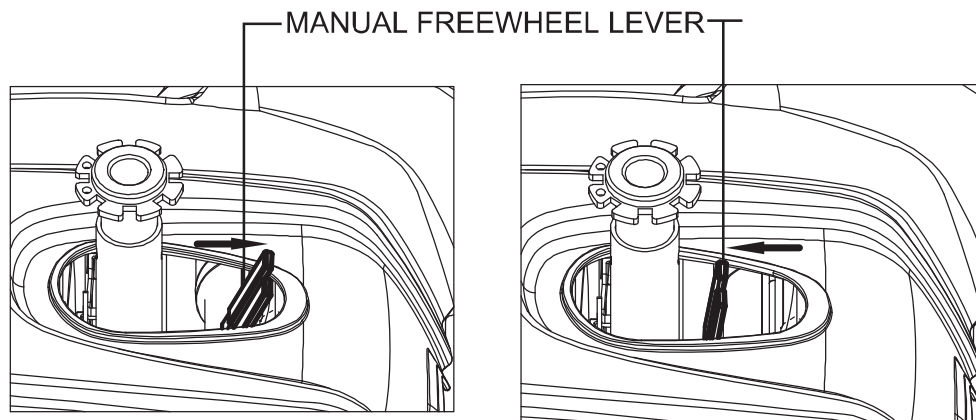

Fig L1. Drive Mode (Drive Engaged)

Fig L2. Freewheel Mode (Drive disengaged)

■ VR2 Controller Operation:

The VR2 control system has two versions of the front control panel - with and without actuator control. Most of the controls are common to both versions, however, the actuator buttons are only included on VR2 control systems with seat actuator control. Each of the controls is explained within this section.

VR2 USER CONTROLS

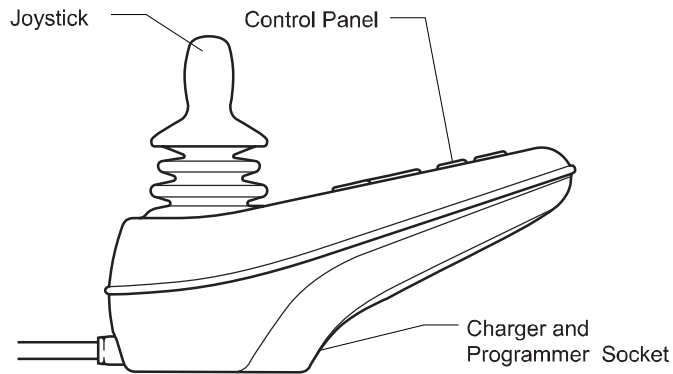

Front Control Panel Details

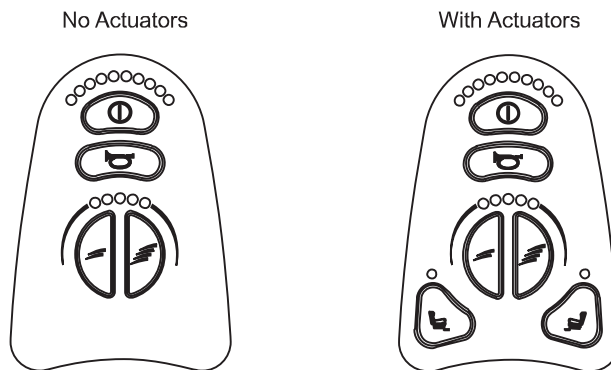

VR2 CONTROL BUTTONS

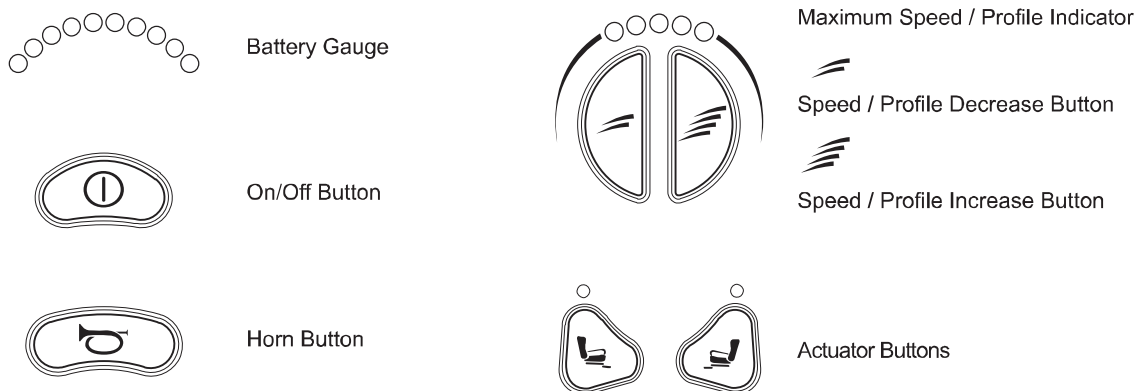

On/Off Button and Battery Gauge

The on/off button applies power to the control system electronics, which in turn supplies power to the wheelchair's motors. Do not use the on/off button to stop the wheelchair unless there is an emergency. (If you do, you may shorten the life of the wheelchair drive components).

The battery gauge shows you that the wheelchair is switched on. It also indicates the operating status of the wheelchair. Details are given in section 1.

1 Control System Status indication

The battery gauge and maximum speed / profile indicator show the status of the control system.

A number of supposedly defective control systems returned to us are subsequently found to operate correctly. This indicates that many reported faults are due to wheelchair problems rather than the control system.

1.1 Battery Gauge is Steady

This indicates that all is well.

1.2 Battery Gauge Flashes Slowly

The control system is functioning correctly, but you should charge the battery as soon as possible.

1.3 Battery Gauge steps Up

The wheelchair batteries are being charged. You will not be able to drive the wheelchair until the charger is disconnected and you have switched the control system off and on again.

1.4 Battery Gauge Flashes Rapidly (even with the joystick released)

The control system safety circuits have operated and the control system has been prevented from moving the wheelchair.

This indicates a system trip, i.e. the VR2 has detected a problem somewhere in the wheelchair's electrical system. Please follow this procedure.

- Switch off the control system.
- Make sure that all connectors on the wheelchair and the control system are mated securely.
- Check the condition of the battery.
- If you can't find the problem, try using the self-help guide given in section 1.5.
- Switch on the control system again and try to drive the wheelchair. If the safety circuits operate again, switch off and do not try to use the wheelchair.

Contact your service agent.













1.5 Self-Help Guide

If a system trip occurs, you can find out what has happened by counting the number of bars on the battery gauge that are flashing.

Below is a list of self-help actions. Try to use this list before you contact your service agent. Go to the number in the list which matches the number of flashing bars and follow the instructions.

If the problem persists after you made the checks described below contact your service agent.

* If the programmable parameter, Motor Swap has been enabled, then left and right hand references in this table will need transposing.

	The battery needs charging or there is a bad connection to the battery. Check the connections to the battery. If the connections are good, try charging the battery.
	The left hand motor* has a bad connection. Check the connections to the left hand motor.
	The left hand motor* has a short circuit to a battery connection. Contact your service agent.
	The right hand motor* has a bad connection. Check the connections to the right hand module.
	The right hand motor* has a short circuit to a battery connection. Contact your service agent.
	The wheelchair is being prevented from driving by an external signal. The exact cause will depend on the type of wheelchair you have, one possibility is the battery charger is connected.
	A joystick fault is indicated. Make sure that the joystick is in the center position before switching on the control system.
	A control system fault is indicated. Make sure that all connections are secure.
	The parking brakes have a bad connection. Check the parking brake and motor connections. Make sure the control system connections are secure.
	An excessive voltage has been applied to the control system. This is usually caused by a poor battery connection. Check the battery connections.
	A communication fault is indicated. Make sure that joystick cable is securely connected and not damaged.
	An Actuator trip is indicated. If more than one actuator is fitted, check which actuator is not working correctly. Check the actuator wiring.

1.6 Slow or sluggish movement

If the wheelchair does not travel at full speed or does not respond quickly enough, and the battery condition is good, check the maximum speed setting. If adjusting the speed setting does not remedy the problem then there may be a non-hazardous fault. Contact your service agent.

1.7 Maximum Speed / Profile Indicator is Steady

The display will vary slightly depending on whether the control system is programmed to operate with drive profiles.

1.7.1 Maximum Speed Indication

The number of LEDs illuminated shows the maximum speed setting. For example, if the setting is speed level 4, then the four left hand LEDs will be illuminated.

1.7.2 Profile Indication

The LED illuminated shows the selected drive profile. For example, if drive profile 4 is selected, then the fourth LED from the left will be illuminated.

1.8 Maximum Speed / Profile Indicator Ripples Up and Down

This indicates the control system is locked.

1.9 Maximum Speed / Profile Indicator Flashes

This indicates the speed of the wheelchair is being limited for safety reasons. The exact reason will depend on the type of wheelchair, however, the most common cause is that the seat is in the elevated position.

VR2 POWER MODULE CONNECTIONS

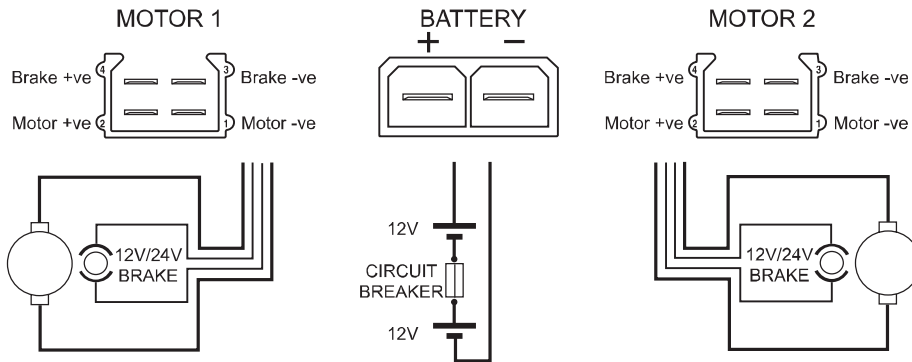
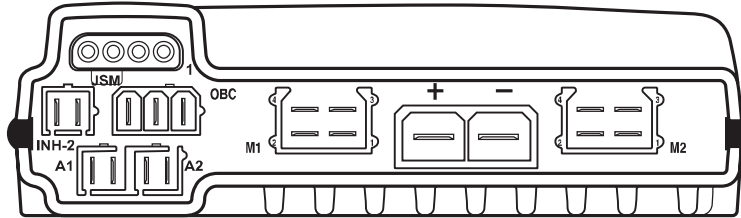

INHIBIT 2



INH-2	Function
1	0V
2	Inhibit 2

ON-BOARD CHARGER

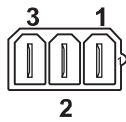

OBC	Function
1	Battery +ve
2	Inhibit 3
3	0V

ACTUATORS

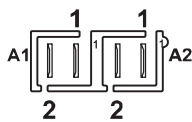

Joystick Movement	Pin 1	Pin 2	Actuator Movement
Forward	+ve	-ve	Channel Up
Backward	-ve	+ve	Channel Down

► Operating your powerbase wheelchair ◀

Batteries and Charging

Your Power Wheelchair uses two long-lasting, 12-volt batteries. These batteries are sealed, maintenance free, deep-cycle batteries. Since they are sealed, there is no need to check the electrolyte (fluid) level. Deep-cycle batteries are designed to handle a deep discharge. Though they are similar in appearance to automotive batteries, they are not interchangeable. Automotive batteries are not designed to handle a long, deep discharge, and are also unsafe for use in power wheelchairs.

WARNING! Battery posts, terminals and related accessories contain lead and lead compounds. Wash hands after handling.

BATTERY BREAK-IN

To break in your power wheelchair new batteries for maximum efficiency:

1. Fully recharge any new battery prior to initial use. This will bring the battery up to about 90% of its peak performance level.
2. Run your power wheelchair about the house. Move slowly at first, and do not stray too far until you become accustomed to the controls and break in the batteries.
3. Give the batteries another full charge of 8 to 14 hours and operate the power wheelchair again. The batteries should now perform at over 90% of their potential.
4. After four or five charging cycles, the batteries will top off at 100% charge and last for an extended period.

IMPORTANT INFORMATION ABOUT BATTERIES

A fully charged deep-cycle battery provides reliable performance and extended battery life. Keep your batteries fully charged whenever possible. Batteries that are regularly discharged, infrequently charged, or stored without a full charge may be permanently damaged, causing unreliable operation and limited battery life.

If you do not use your power wheelchair regularly, we recommend maintaining battery vitality by charging the batteries at least once a week.

Warning: Use only the battery charger supplied with the chair or an approved substitute of equal voltage and current output

Note: If you are storing a power wheelchair for an extended period of time, you may wish to block the unit up off the ground with several boards under the frame. This keeps the tires off the ground to prevent the possibility of flat spots developing.

If you intend to use public transportation while using your power wheelchair, you must contact in advance the transportation provider to determine their specific requirements.

Sealed Lead Acid and Gel Cell batteries are designed for application in wheelchairs and in other mobility vehicles. Generally, Sealed Lead Acid batteries that are marked as "Non-Spill" are safe for all forms of transportation such as aircraft, buses, and trains. We suggest that you contact your transportation provider to determine specific requirements of transportation and packaging.

If you wish to use a freight company to ship the power wheelchair to your final destination, repack the power wheelchair in the original shipping container and ship its batteries in separate boxes.

Charging Your Batteries

The battery charger is one of the most important parts of your power wheelchair. Optimize your power wheelchair performance by charging the batteries safely, quickly, and easily. Use only the charger supplied with the vehicle.

Charging Procedures

1. Plug the charger outlet plug into the charging socket in the front of the controller, then plug the charger input plug into an electrical outlet.
2. Follow the instructions on the front panel of the charger for operating and learn the meanings of the different indicators accordingly.
3. Minimum charging time varies depending on battery condition and discharge level. It is recommended to charge the batteries overnight.

NOTE: The specially designed charger assures that excess power is not consumed regardless of how long it is switched on, and connected to the batteries.

4. Once charging is complete, disconnect the charger from the electrical outlet and then disconnect the charger from the controller socket. Do not leave the charger connected to controller when input power is disconnected. It is dangerous and will jeopardize the power charging to the batteries.

CARE AND MAINTENANCE

Your powerbase wheelchair requires a minimal amount of care and maintenance. If you do not feel confident in your ability to perform the maintenance listed below, you may schedule inspection and maintenance at your authorized dealer. The following areas require periodic inspection and/or care and maintenance.

Exterior surfaces

Battery pack, and tires can benefit from an occasional application of rubber or vinyl conditioner.

Do not use a rubber or vinyl conditioner on the powerbase wheelchair's vinyl seat or tire tread, as this may cause them to become dangerously slippery.

Cleaning and disinfection

- Use a damp cloth and mild, non-abrasive cleanser to clean the plastic and metal parts of your powerbase wheelchair.

Avoid using products that may scratch the surface of your powerbase wheelchair.

- If necessary, clean your product with an approved disinfectant. Make sure the disinfectant is safe for use on your product before application.
- Follow all safety instructions for the proper use of the disinfectant and cleaning agent before applying it to your product. Failure to comply may result in skin irritation or premature deterioration of upholstery and/or scooter finishes.

Battery terminal connections

- Make certain that the terminal connections remain tight and uncorroded.
- The batteries must sit flat in the battery wells.

ABS plastic shrouds

- The Main Shroud is are formed from durable ABS plastic and is coated with an advanced formula urethane paint.
- A light application of car wax will help the shrouds retain their high gloss.

Motor brushes

The motor brushes are housed inside of the motor transaxle/assembly. They should be inspected periodically for wear by your authorized dealer.

AXLE BEARINGS AND THE MOTOR/TRANSAXLE ASSEMBLY

You do not need to lubricate these items, as they are all prefabricated and sealed.

DAILY CHECKS

- With the controller turned off, check the joystick. Make sure it is not bent or damaged and that it returns to center when you release it. Check the rubber boot around the base of the joystick for damage. Visually inspect the boot only. Do not handle or try to repair it. See your authorized service center if there is a problem.
- Visually inspect the controller harnesses. Make sure that they are not frayed, cut or have any wire exposed. See your authorized provider if there is a problem with any of these harnesses.

WEEKLY CHECKS

- Disconnect and inspect the controller and charger harnesses from the electronics connector housing. Look for corrosion. Contact your local provider if necessary.
- Ensure that all parts of the controller system are securely fastened to your powerbase wheelchair. Do not over tighten any screw.
- Check for proper tire inflation, there should be 30-35psi in each tire. If a tire will not hold air, replace the tube.
- Calibrate the joystick if a noticeable difference in performance is detected or if the joystick does not operate properly.
- Check the brakes. This test should be carried out on a level surface with at least three feet of clearance around your powerbase wheelchair.

To check the brakes:

1. Turn on the controller and turn down the speed response adjustment knob.
2. After one second, check the battery gauge. Make sure that it remains on.
3. Slowly push the joystick forward until you hear the electric brakes click.

Note: The powerbase wheelchair may move when performing this test. Immediately release the joystick. You must be able to hear each electrical brake operating within a few seconds of joystick movement.

MONTHLY CHECKS

- Check that the anti-tip wheels do not rub the ground when you are operating the powerbase wheelchair; adjust them as necessary.
- Check for extreme wear on the anti-tip wheels. Replace them as necessary.
- Check for drive tire wear. See an authorized provider for repair.
- Check the front/rear castors for wear. Replace as necessary.
- Check the front/rear forks for damage or fluttering which indicates that they may need to be adjusted or the bearings may need to be replaced. See an authorized provider for repair.
- Keep your powerbase wheelchair clean and free of foreign material such as hair, food, drink, etc.

YEARLY CHECKS

- Take your powerbase wheelchair to an authorized provider for yearly maintenance. This helps to ensure that your powerbase wheelchair is functioning properly and helps prevent future complications.

Replacement

If your powerbase wheelchair is equipped with pneumatic tires and you have a flat tire, you can have the tube replaced.

If your powerbase wheelchair is equipped with a solid tire insert, either the solid insert or the entire wheel must be replaced depending on the model. Contact your dealer for information regarding replacement wheels for your powerbase wheelchair.

Be sure that the powerbase wheelchair is powered off and the powerbase wheelchair is not in freewheel mode before performing this procedure.

Follow these easy steps for a quick and safe repair for solid tires:

1. Push the ON/Off switch button to turn off the power.
2. Elevate the side of the powerbase wheelchair of which you are removing the tire. Place wooden blocks under the frame to elevate the powerbase wheelchair.
3. Remove the drive wheel nut and washer from the axle.
4. Pull the wheel off the axle.
5. Slide the new wheel back onto the axle. If you are replacing a drive wheel. Make sure that the axle key is in the axle slot.

Failure to ensure that the axle key is properly installed into the axle slot when mounting the wheel can result in electronic brake failure, personal injury, and product damage.

6. Reinstall the wheel washer and nut onto the axle and tighten.
Make sure both the nut and washer are reinstalled and tightened properly.
7. Remove the block from beneath the powerbase wheelchair.

Wiring harnesses

- Regularly check all wiring connections.
- Regularly check all wiring insulation, including the charger power cord, for wear or damage.
- Have your authorized dealer repair or replace any damaged connector, connection, or insulation that you find before using your powerbase wheelchair again.
- Even though the powerbase wheelchair has passed the necessary testing requirements for ingress of liquids, you should keep electrical connections away from sources of dampness, including direct exposure to water or bodily fluids and incontinence. Check electrical components frequently for signs of corrosion and replace as necessary.

Nylon lock nut replacement

Any nylon insert lock nut removed during the periodic maintenance, assembly, or disassembly of the scooter must be replaced with a new nut. Nylon insert lock nuts should not be reused as it may cause damage to the nylon insert, resulting in a less secure fit. Replacement nylon insert lock nuts are available at local hardware stores or through your dealer.

Console, charger, and electronic controller module

- Keep these areas away from moisture.
- Before operating your powerbase wheelchair, allow any of these areas to dry thoroughly if they have been exposed to moisture.

Fuses

To replace a fuse:

1. Remove the fuse by pulling it straight out of its slot.
2. Examine the fuse to be sure it is blown.
3. Insert a new fuse of the proper rating.

Storing your powerbase wheelchair

If you plan on not using your powerbase wheelchair for an extended period of time, it is best to:

1. Fully charge its batteries prior to storage.
2. Disconnect the batteries from the powerbase wheelchair.
3. Store your powerbase wheelchair in a warm, dry environment.
4. Avoid storing your powerbase wheelchair where it will be exposed to temperature extremes.

Always protect batteries from freezing temperatures and never charge a frozen battery. Charging a frozen battery can result in damage to the battery.

Recycle

Information on the recycling of used batteries and other parts of the powerbase wheelchair; use only special recycling for the powerbase wheelchair parts, no general disposal (e.g. batteries, electronics)

PART LIST





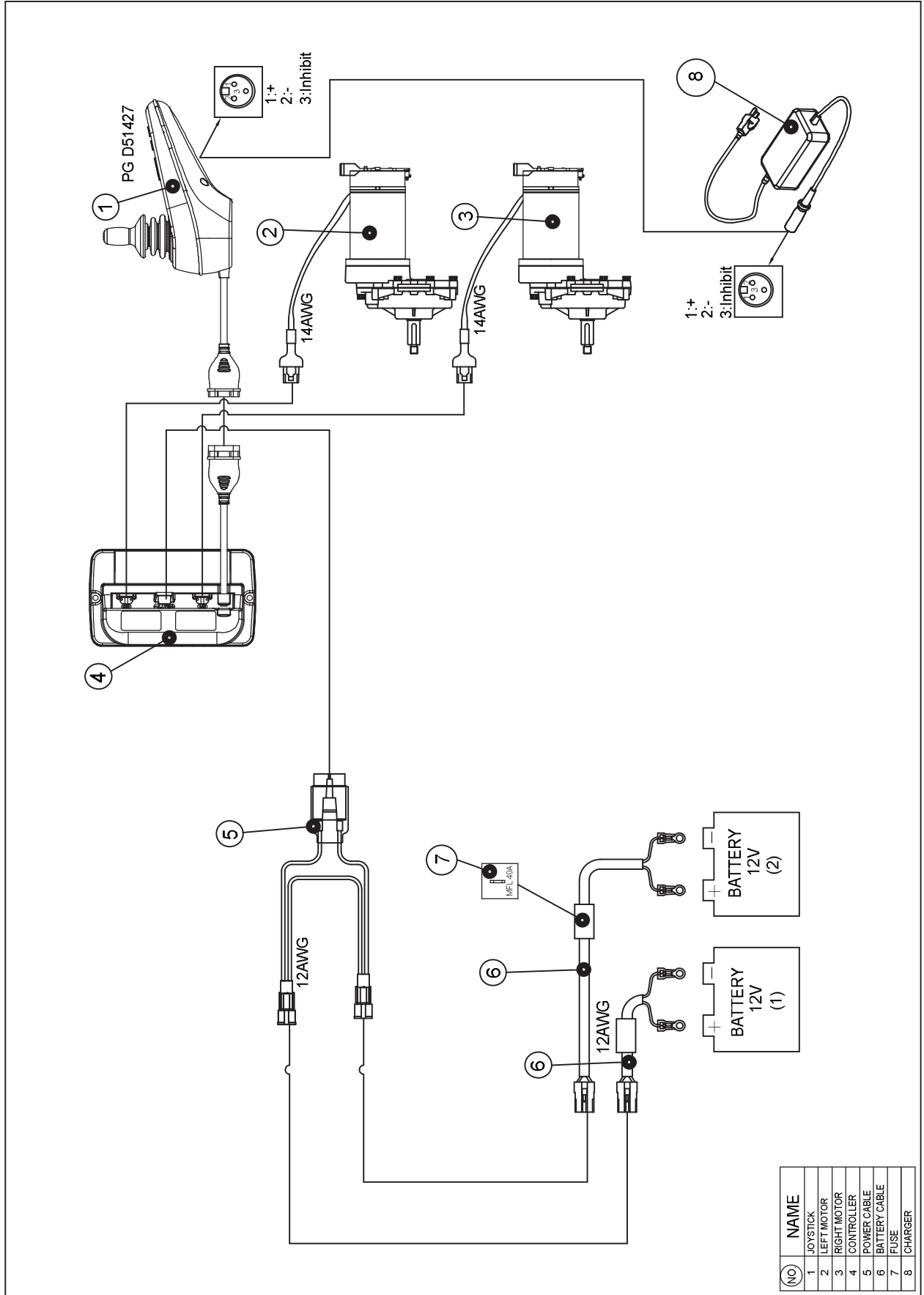

PART LIST	
Item	Description
①	Seat Ass'y
	Captain Seat, 18W*15D*17H
	Pad, Armrest
②	Motor and Gearbox Complete, LH and RH.
	Motor & Gearbox Ass'y., M9M01HA-12, LH
	Motor & Gearbox Ass'y., M9M01HA-12, RH
	Motor Ass'y., M9HA-12, LH
	Motor Ass'y., M9HA-12, RH
	Gearbox Ass'y., M9M01
③	Caster Wheel with Fork Ass'y.
	Caster W/Fork, 6*2" PU
④	Drive wheel Ass'y.
	Rear Wheel Ass'y., LH, PU
	Rear Wheel Ass'y., RH, PU

PART LIST	
Item	Description
⑤	Controller
	Joystick Bracket Ass'y., PG nVR2, ED
	Joystick, PG nVR2, JSM(D51427)
	Controller, P&G nVR2, PM 50(D51425)
⑥	Shroud Ass'y
	Shroud
	Battery Pack
⑦	Footplate Ass'y.
	Footrest Plate
⑧	Charger Unit
	Charger, HP1211B-4A-Off-Board

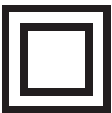

IEC Symbols

	Direct current
IPX4	Protect against splashing water
	Attention, consult accompanying document.
	ON/ OFF Button on the controller
5/5	Use DC24V/5A charger
	Read
	Type B applied part
	Class II Equipment

Serialization format for products

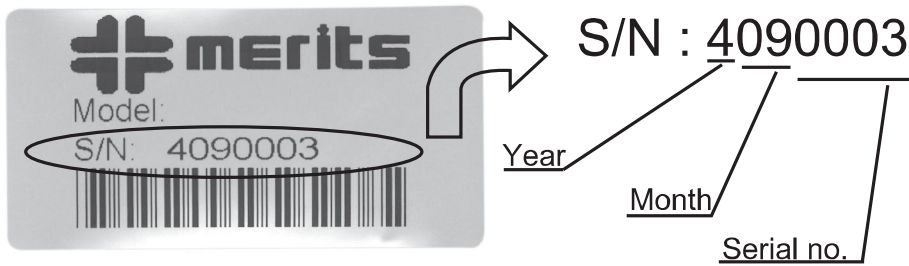

1	The first digit is the last one digit of the year for manufacture.
2	The second and third digits are the month for manufacture.
3	The fourth to seventh digits are counting of how many units were manufactured during the month.

► Warranty ◀

Limited Warranty

Corporation warrants to the original purchaser of this wheelchair product that it is free of defect in material and workmanship and that, when operated within the guidelines and restrictions of this manual, will remain so free of defect in material and workmanship for a period of One (1) year from the original date of purchase.

Excluded from this warranty is failure due to negligence, abuse, accident, operation outside of rated limits, commercial or institutional use, damage / wear to upholstery or tires and improper maintenance or storage. The batteries for this wheelchair product are not supplied by Corporation; contact the battery manufacturer / supplier if warranty replacement is requested.

This wheelchair product must not be modified in any way without the express written consent of Corporation. Any such unauthorized modification could cause unreliable and / or unsafe operation and will void this warranty.

Where a failure occurs within the 1- year warranty period that is not excluded above, the failed components will be replaced with similar new or reconditioned components at sole option of the corporation. Corporation will not be responsible for labor and / or shipping charges.

The foregoing warranty is exclusive and in lieu of all other warranties expressed or implied including, but not limited to, the implied warranty of merchantability and fitness for a particular purpose. Corporation will not be liable for any consequential or incidental damages whatsoever.

► **Warranty Registration** ◀

WARRANTY REGISTRATION

MODEL NO. _____

SERIAL NO. _____

DATE PURCHASED _____

NAME _____

ADDRESS _____

CITY _____ STATE _____ ZIP _____

DEALER NAME _____

STAMP

RETURN ADDRESS

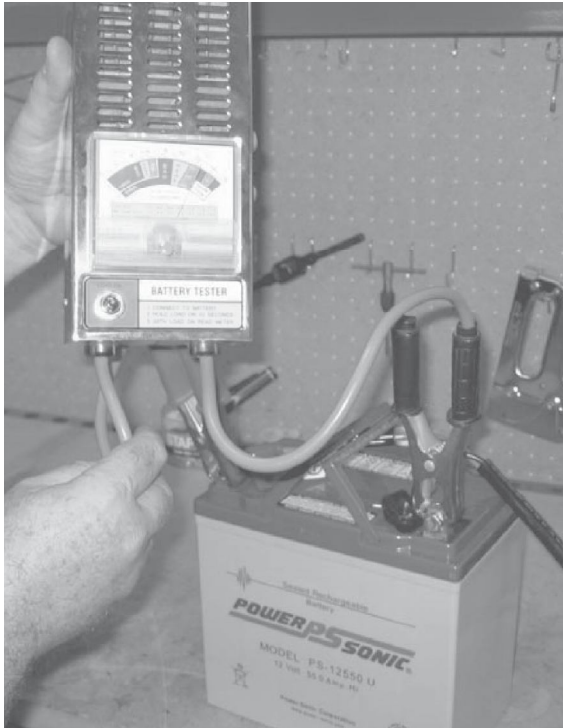

Figure 1



Figure 2

TROUBLESHOOTING TIPS

If your power chair or scooter is not operating properly, please take the following steps prior to calling Technical Support.

Load-test Batteries—See Figure 1

1. Attach Battery Load-tester to battery.
Observe polarity: Red is Positive—Black is Negative
2. Hold load switch on for 10 seconds. A good reading is 11.2 Volts DC, or in the Green.

Note: A Voltmeter cannot load-test batteries.

Test Voltage—See Figure 2

Utilizing a Voltmeter, place meter leads in charging port. The voltage reading should be 25 Volts DC, plus or minus 2 volts.

Note: Batteries are connected in series.

If the above tests are successful, proceed with the following test.

1. For power chairs, elevate to drive wheels
2. Turn on controller and run in all four quadrants.
3. If troubleshooting a scooter, elevate rear wheels and run in Forward and Reverse.

If any of the above tests fail, contact your local dealer.

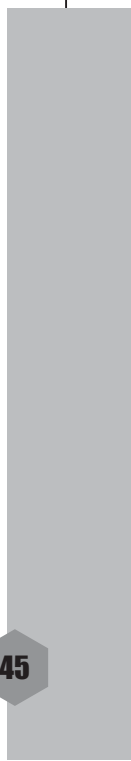

We wish you a safe and comfortable riding experience!





MERITS HEALTH PRODUCTS, INC.

www.meritshealth.com 730 N.E. 19th Place, Cape Coral, FL 33909
TEL: 1-800-963-7487, 1-239-772-0579 FAX: 1-239-574-2661