

Free Standing Track



Owner's Manual

Use and Care
Trouble Shooting

Table of Contents

Free Standing Track

Introduction	3
Overview.....	3
Placement of the Free Standing Track	4
Components of system.....	5
Component list.....	6
Specifications	6
Cautions.....	7
Assembly	
Opening of package	11
Assembling the Side Supports	12
Assembly of the Track	15
Assembly– Mounting the Track	17
Mounting the C-300 Lift	20
Mounting the P-300 Lift	21
Raising up the Free Standing Track System	22
Full raised Free Standing Track	25
Disassembly of Free Standing Track	26
Disassembly of Post	30
Packaging of Post	31
Packaging of Track	32
Packaging of Rolling Bag	33
Trouble Shooting	34
General Inspection and Maintenance	36
Service Record History—Initial Information	38
Service record History	39
Contact Information.....	42



CAUTION: DO NOT ATTEMPT TO USE THIS EQUIPMENT WITHOUT FIRST UNDERSTANDING THE CONTENTS OF THIS MANUAL.

Introduction

Before using this equipment, and to ensure the safe operation of your Free Standing Track system, carefully read this entire manual, especially the section on “**Cautions**”. The Free Standing Track system is designed to be used in conjunction with Prism Medical Ltd. portable lift units, accessories and slings. Please refer to any user guides supplied with these components and reference them while reviewing this manual.

Should any questions arise from reviewing this manual contact your local authorised Prism Medical Ltd. dealer. Failure to comply with warnings in this manual may result in injury to the operator, or the individual being lifted/transferred. Damage to the lift and/or related components may occur. Be sure that the contents of this manual are completely understood prior to using this piece of equipment.

Store this manual with the documents included with the lift system and sling (s). Contents of this manual are subject to change without prior written notice.

Overview of the Free Standing Track System

The Free Standing Track system is a lifting aid to help lift, position and transfer clients or a disabled family member. The Free Standing Track system is part of what is termed overhead lift technology which takes advantage of lifting from above and not from below or the side. The Free Standing Track system makes it possible to move mobility impaired individuals with minimal strain or risk to the caregiver, while providing complete safety, dignity and comfort for the client or family member.

The Free Standing Track system is designed to work with a Prism Medical Ltd portable lift system such as the P/C-300 (Free Standing Track Maximum Safe Working Load is 300lbs). Use of other portable lift units with this system may be possible. However, please contact your local authorised Prism Medical Ltd dealers in order to obtain approval before use.

The Free Standing Track system is a floor based free standing system that can be used to lift and transfer individuals from a bed, chair or similar fixture. It needs basic level of expertise to assemble or setup. It is easy to assemble and can be completed by just one person in a short period of time. Additionally, no tools are required. It is also light weight and once dismantled, can be moved to another location. Its quick setup (less than 5 minutes) and lightweight assemblies allows the caregiver to transport and transfer the client with minimum effort.

Please review the following pages that outline the parts included with your package. Should you have any questions about this product or its use contact your local authorised dealer.

General Placement

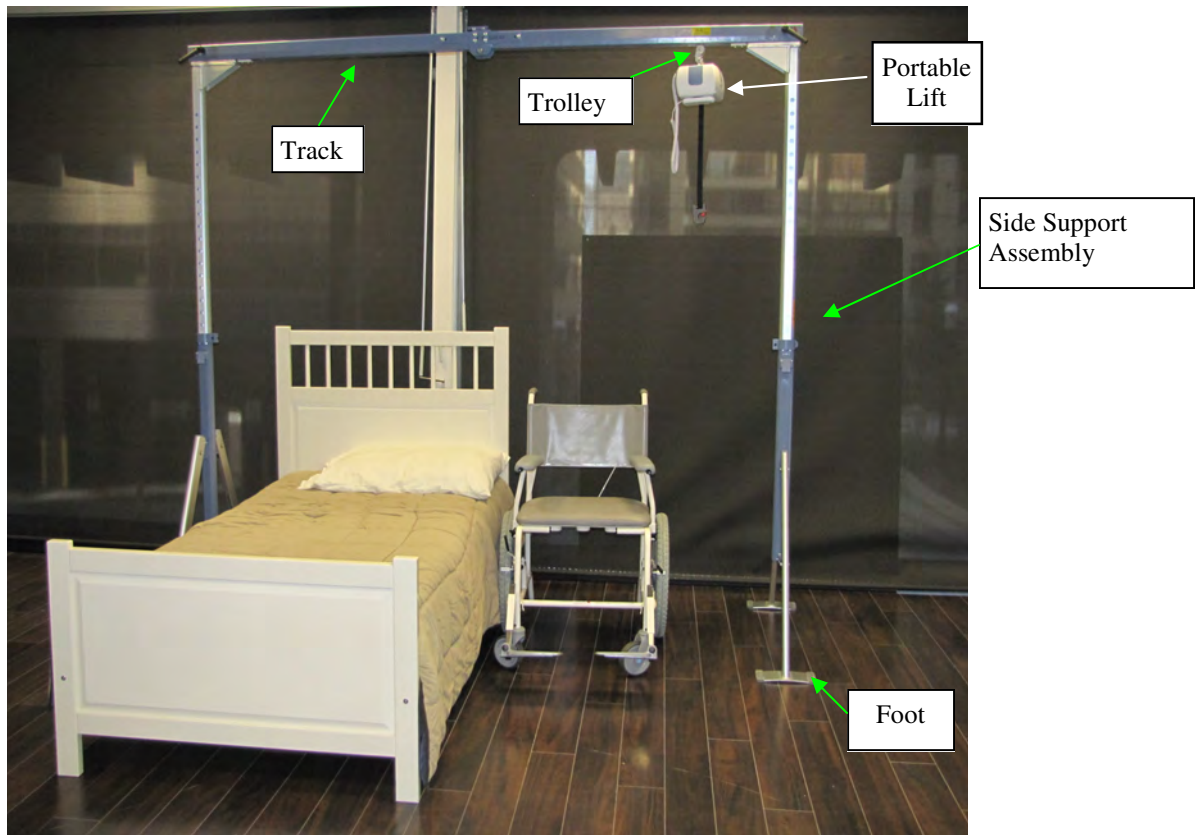

Photo showing Side View and the general placement of a bed in relationship to the Free Standing Track.

General Placement Requirements

- 1) The Bases of the Free Standing Track must always be placed on a hard level surface.
- 2) Do not place the Bases on surfaces that will cause them to wobble or be unstable. Make sure the surfaces are free of any obstacles that may cause the Bases to be unstable.
- 3) Never place the Bases on wet surfaces.
- 4) Assemble the Free Standing Track so that the Track is directly over the location where the transfer will occur. For beds this is generally between 39" - 45" (1000mm - 1145mm) from the head of the bed. For wheelchairs, living room chairs, recliner chairs and similar furniture this is directly above the middle (center) of the seat.

Components of the Free Standing Track

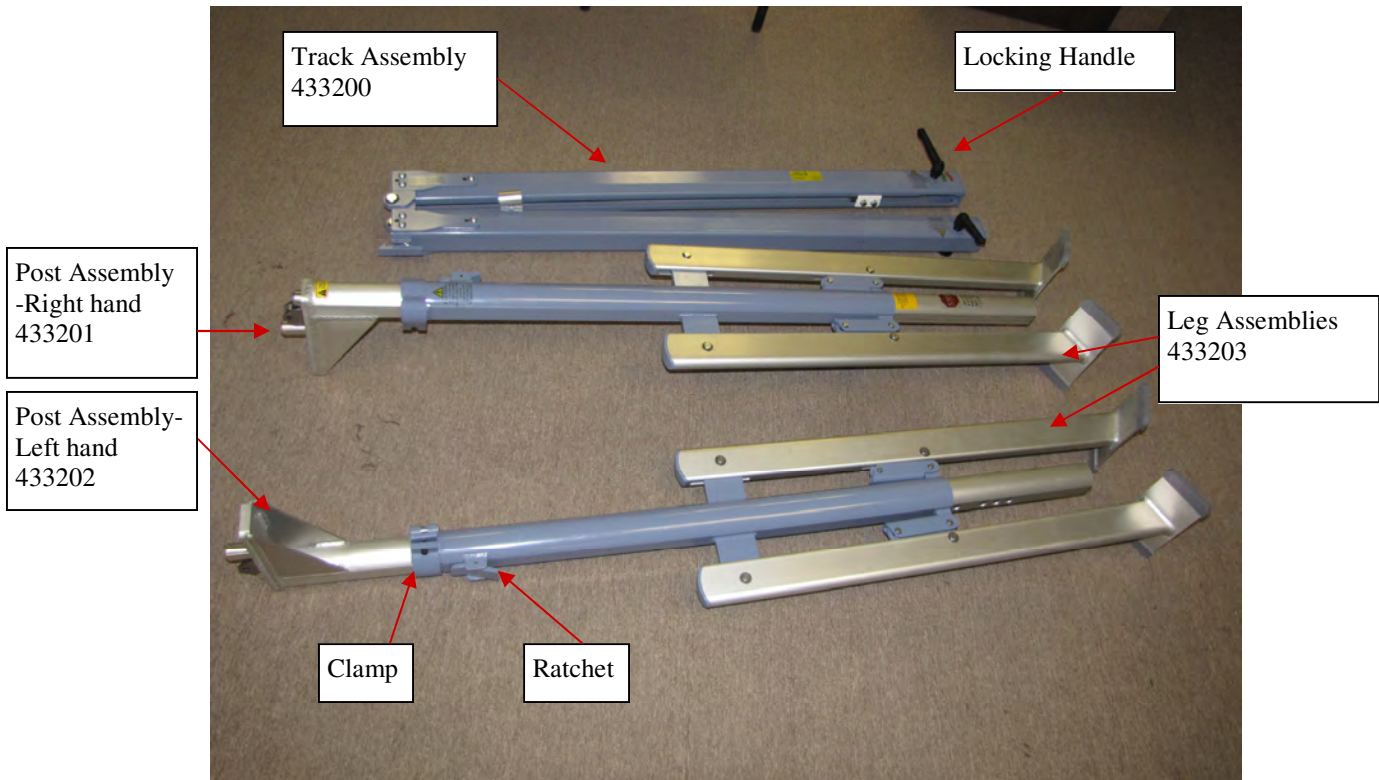

Figure 1A - Disassembled Free Standing Track.

Minimum - Maximum Dimensions



3' Wide (W) x 5-7.5' Adjustable Height (H) x 8' Length (L)

Component List

The following components are included with your Free Standing Track:

Description	Part Number	Quantity
Post Assembly-RH	433201	1
Post Assembly-LH	433202	1
Track Assembly	433200	1
Leg Assembly	433203	2
Owners Manual	633282	1



CAUTION:
DO NOT EXCEED THE CAPACITY OF THE FREE STANDING TRACK
 (Maximum Safe Working Load of 300 LBS)

Specifications of the Free Standing Track

- High-strength lightweight Aluminum
 - Track weight is 15 lbs
 - Post and leg assembly weight 12 lbs
 - Unit weight is 41 lbs including trolley
- Portable installation
- Eliminates the mounting of a connection system in the ceiling
- One person set up (less than 5 minutes)
- Addresses a number of different set ups
- Weight capacity Maximum Safe Working Load of 300lb
- Adjustable in height
 - Minimum height 5 feet
 - Maximum height 7.5 feet
 - Height adjustable in “2 inches” increments

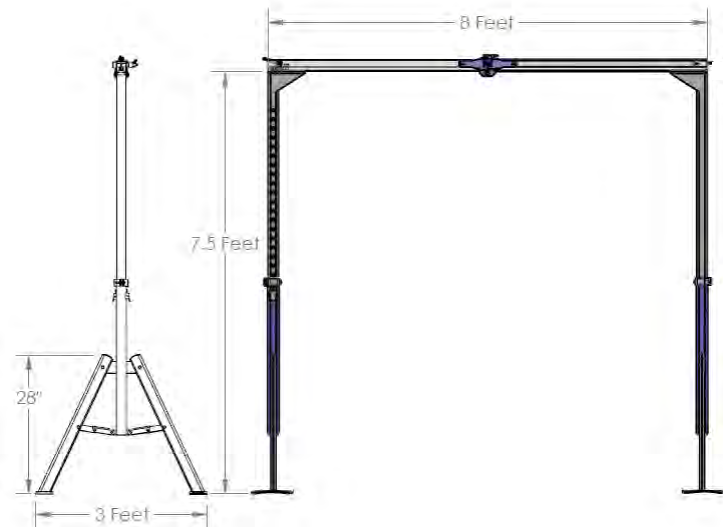

Model Table for the FST-300 System	
Code	Description
341400	Free Standing Track



Before you start: Check Requirements and Cautions

Cautions:



Failure to observe cautions listed below could result in serious injury or death.

- The Free Standing Track system must be assembled prior to use. Should you have any questions during assembly contact your local authorised dealer.
- The Free Standing Track system parts should not be loose, broken or bent. If any part is missing or damaged do not install. Contact your local authorised dealer immediately.
- Under no circumstance should the track, lift and sling (s) or entire system be put in control of a person who has not been properly trained in the use and care of this equipment. Failure to adhere to this warning may result in serious injury to the operator, and/or the individual being lifted/transferred.
- Never expose the Free Standing Track directly to water. Warranty does not cover any misuse or abuse of the Free Standing Track system.
- Any accessories used with the Free Standing Track including lift and sling (s), should be checked to ensure that they are in good working order. Check for signs of wear or fraying prior to use. Report any unusual wear or damage immediately to your local authorised dealer.
- The Free Standing Track and associated lift, and sling (s) are intended **only** for lifting and transferring of a person. Prism Medical Ltd. will not be responsible for any damage caused by the misuse, neglect or purposeful destruction of the lift and/or its' associated components.
- The installation of the Free Standing Track, lift, accessories, and sling are certified to a maximum load. Do not exceed the maximum rated load of any of the components.
- Ensure that a clear space is maintained around the Free Standing Track. Remove all furniture and other obstacles out of the way before performing a transfer.
- The Free Standing Track has been designed to lift vertically at its maximum load and at maximum height. Do not attempt to lift an individual at an angle to the track.
- Do not install The Free Standing Track on an uneven floor. Do not install on a sloped floor greater than .5 degree.
- Ensure floor area is clear off dirt and debris.
- Do not drop product, it may cause breakage. Protect the Free Standing Track and its accessories during transport.
- Prior to each use of the equipment, complete a visual inspection. A monthly maintenance inspection must be done in order to ensure good operating conditions.
- Make sure the Lift is in Parking spot before raising or lowering the Posts.



Check Requirements and Cautions-continued

Cautions: After Installation

- Ensure that the Handle lock are fully in locked position as per labels.
- Make sure track is sitting properly on the posts. There should be no gap between Track and Track Holders.
- Make sure all four foot pads are sitting flat on the floor. There should be no gap between the foot pads and floor.
- Make sure clamp levers are locked always when in use.
- During the use of Free Standing Track, do not bump or lean against the posts. This might cause system to become unstable.
- In places where more than one operator will be responsible for using the Free Standing Track, associated lift and sling(s), it is imperative that all operators be trained in its' proper use.
- To maintain optimum function, the Free Standing Track should be inspected and maintained on a regular basis. See the section titled "General Inspection and Maintenance".
- The manufacturer's warranty is void if persons unauthorized by Prism Medical perform work on the Free Standing Track System.



Do not attempt to lift the patient at an angle. See below picture.



Assembly

⚠ Caution: Before using the Free Standing Track,- the Post assembly and track must be visually checked to ensure that they are not damaged. Should anything look unusual contact your local dealer prior to use.

Failure to comply with this caution could result in serious injury to the operator, the individual being lifted and/or damage to the Free Standing Track and/or portable lift unit.

Cleaning Rubber Feet :

Prior to each installation, clean the rubber feet with wet cloth soaked with water.

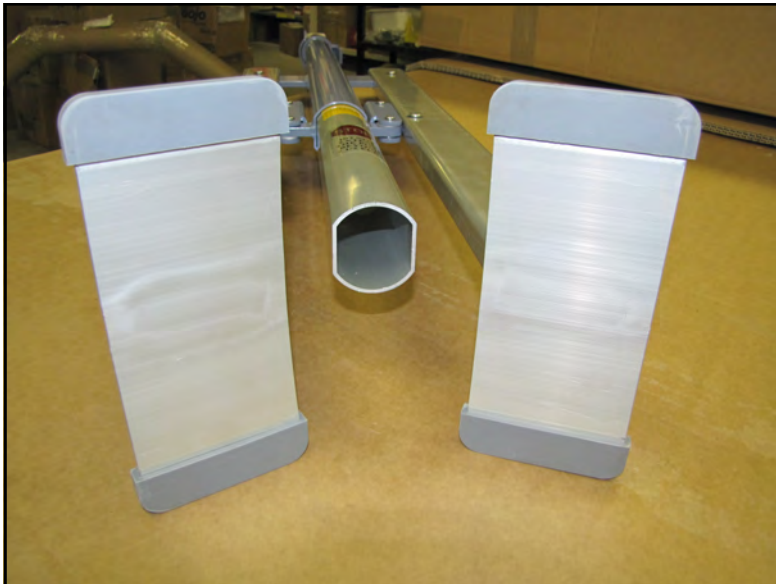

Note:

After cleaning, Make sure the rubber feet are clean and dry with no residue of dirt or dust left on them.

Also, ensure Floor area is cleaned and free of dirt & debris.



Clean all 8 Rubber pieces. Wipe off the dirt with a wet cloth as shown in picture.

Assembly of the supporting Post



Step 1 - Place the Post in Standing Position.



Step 2 - Grab the Side leg to open the foot. Always support the post with one hand and open the leg with the other hand.



Step 3 - Open the other leg of the post. Make sure that the both hinges are flat and they can not go further down.



Step 4 - Completed Post assembly .
Note—Follow Steps 1-4 to finish 2nd post assembly.

Completed Post Assembly of Free Standing Track

Track Holders Must face each other



Trolley Installation

C-300 Trolley

P-300 Trolley

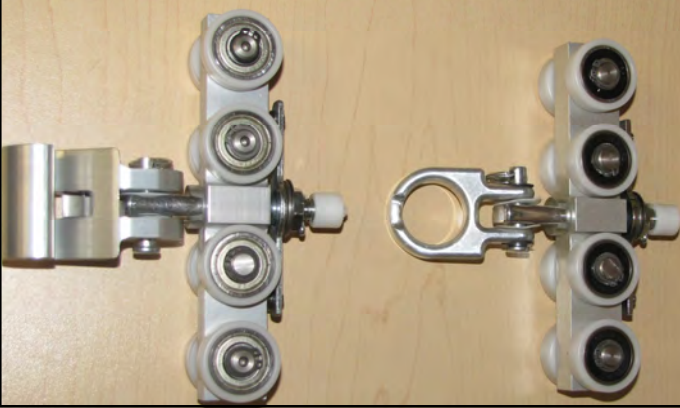

Step 1– Detach the hook/eyelet of trolleys as per step 1 in trolley disassembly (page 27) by removing the split ring and pin.

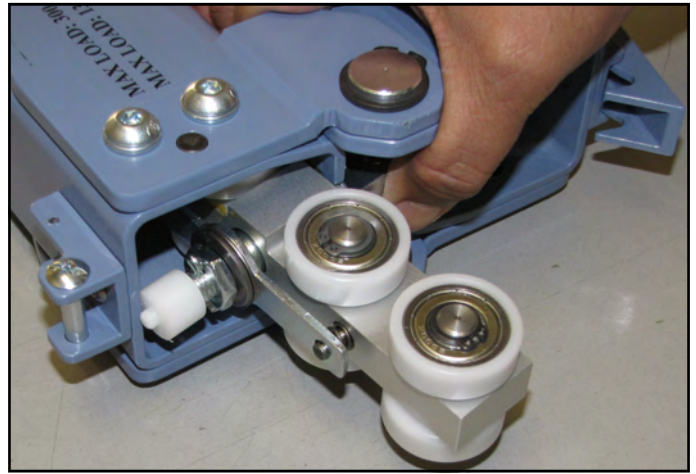

Step 2– Fold and place the track on a secure place. Insert the trolley into the middle of the track.

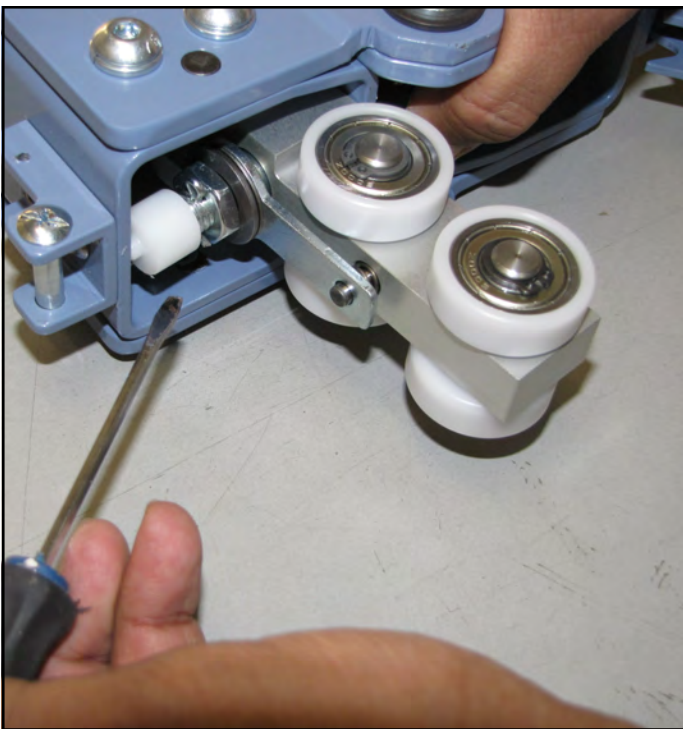

Step 3– Using a screw driver push the trolley lock button down to be able to fit the trolley into the track opening.

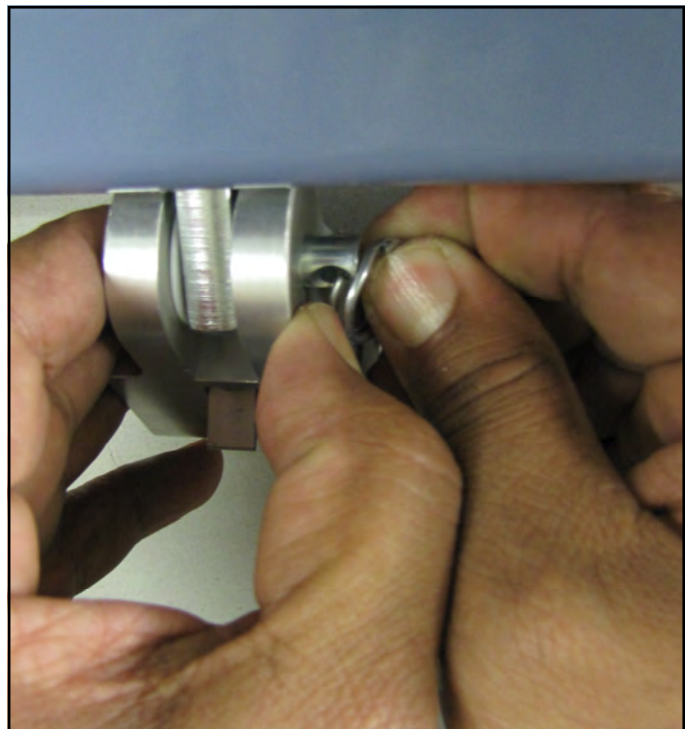

Step 4– Attach the hook/eyelet of the trolley to the trolley using the pin and split ring.

Assembly of the Track

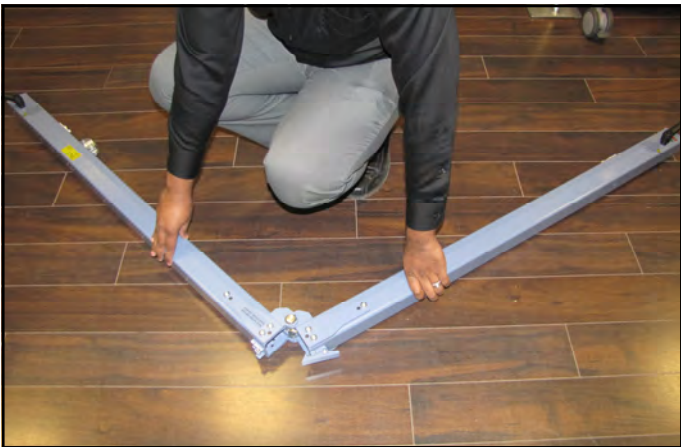

Step 1 - Place the track on the floor. Unfold the track as shown in figure until it is fully straight.

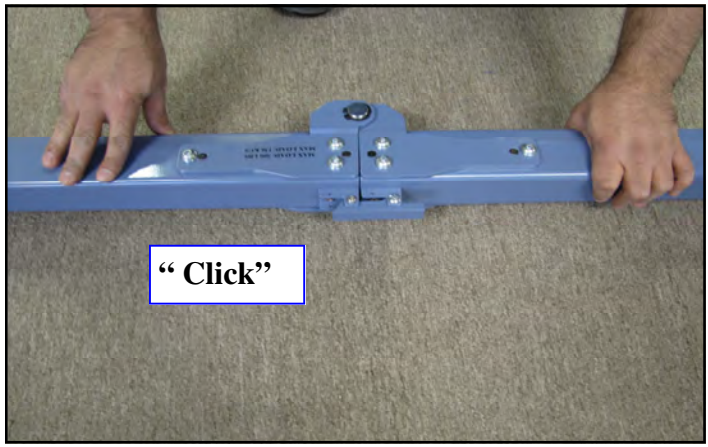

Step 2 - Track should automatically locks itself in place with a “click” sound.
Note: Ensure Track is locked and fully straight.

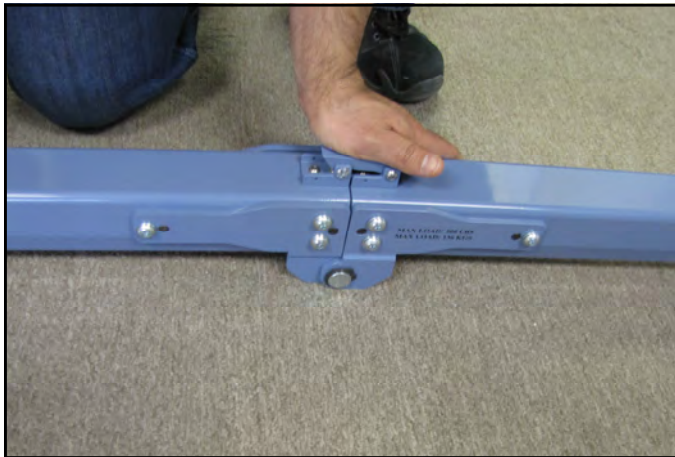

Note: If you do not hear the “click” sound, press the lock with hand until it is in locking position.

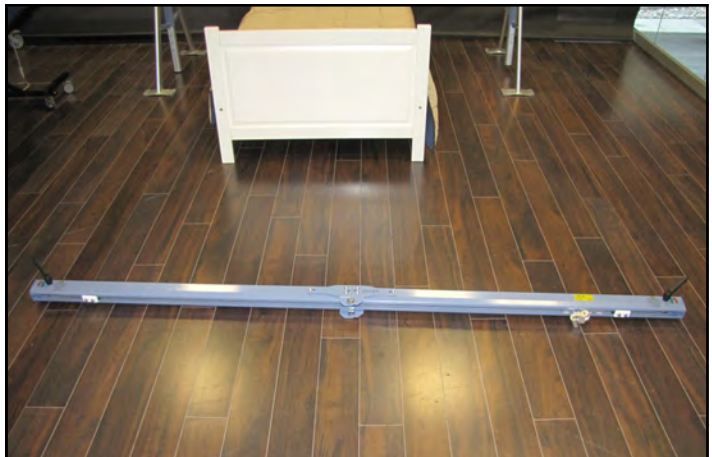

Step 3— Lay Track Flat on the floor.

Assembly—Mounting the Track



Step 1 - Place the Track against the floor.

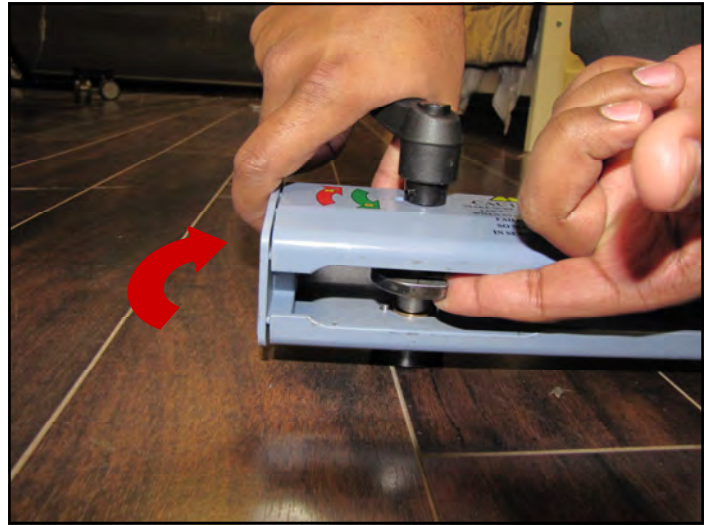

Step 2- Grab the handle and pull the hook inside the track slightly out using a finger and Twist the handle towards the unlock direction until the lock is fully opened.



Step 3– Repeat the same step for other side handle.

Assembly—Mounting the Track



Step 4 - lift the track with both hands and Place one end of the track on the Post Assembly as shown in figure.

Note: always make sure that handles are in open position before placing the track on the post.



Step 5 - Track should fall into place and sit flat on the track holder of the Post as you see in next figure.



Step 6: Place the other end of the track on the other Post.

Note: Make sure there is no gap between the Track and Track Holder.



Step 7— Both ends should lay completely Flat on the top of post assemblies.

Assembly—Mounting the Track Continued...



Step 8 - Grab Track Lock handle



Step 9 - Twist the handle downwards in the lock direction

A big gap should be visible after locking handle

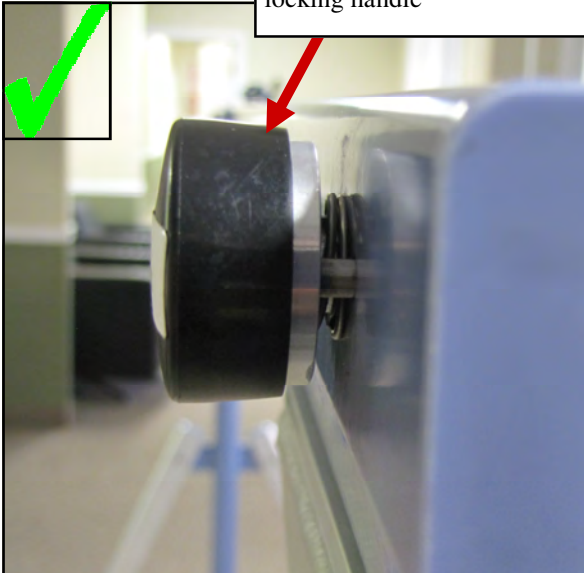

Step 10 - Twist until you hear a click indicating that track is locked in position and the Safety lock pops out.

Note: Big gap between the Track and the safety lock indicates that track is locked as shown above.

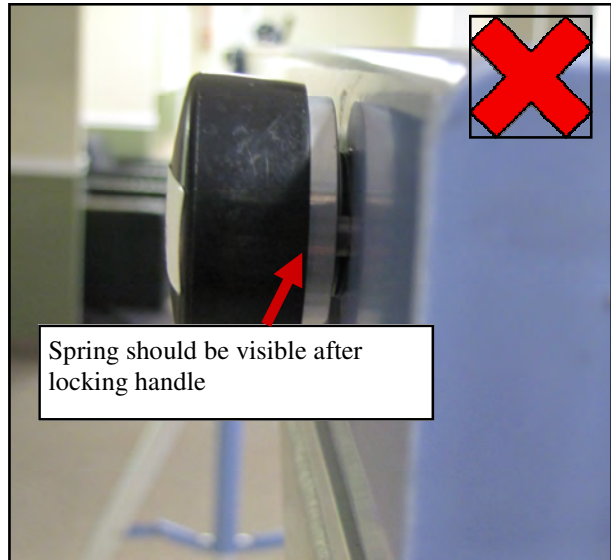

Spring should be visible after locking handle

Note: Above picture shows that the track is not completely locked. You should hear a click sound and spring should be visible.

Step 12 - Repeat steps 9-11 to lock the other side of the Track.

Note: Read instructions for mounting a Portable lift to the Free Standing Track on the next page.

For ease of assembly, Track should be raised up until your eyelevel before mounting the Portable lift .

Mounting the C-300 Lift

⚠ Caution: Prior to mounting the C-300 lift onto the C-300 trolley, read the owners manual of the C-300 lift. Be sure that the instructions on the use of the lift and any accessories, such as slings are thoroughly understood before attempting to use them with the Free Standing Track. Free Standing Track is rated only for 300lbs. Do not exceed the limit of the Free Standing Track.

⚠ FAILURE TO COMPLY WITH THIS MAY RESULT IN INJURY TO THE INDIVIDUAL BEING LIFTED AND/OR THE CAREGIVER, OR DAMAGE TO THE LIFT AND/OR THE FREE STANDING TRACK.

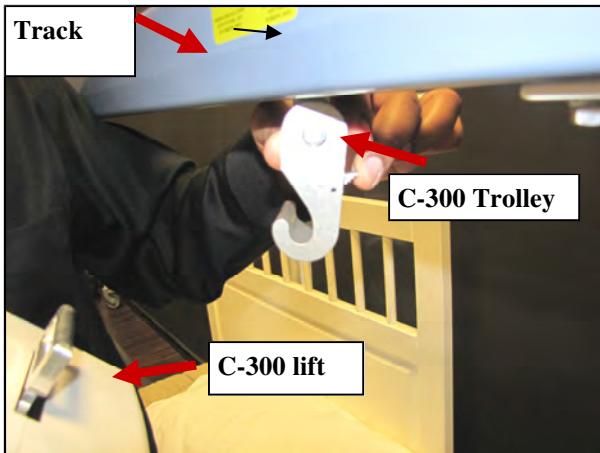

Step 1- Press latch of the trolley from back as shown in figure. Slide the lift hook on to the trolley hook and release the Latch. Follow the figures for the C-300 lift and attach the eyelet of the lift to the hook.



Step 2 - Grab the lift and drag it to the parking spot.

Note:



Note: always make sure that the lift is in parking spot before raising the posts. Apply load and pull the lift down to be able to remove the lift from parking spot and use it.

Mounting the P-300 Lift

⚠ Caution: Prior to mounting the P-300 lift onto the P-300 trolley, read the owners manual of the P-300 lift. Be sure that the instructions on the use of the lift and any accessories, such as slings are thoroughly understood before attempting to use them with the Free Standing Track. Free Standing Track is rated only for 300lbs. Do not exceed the limit of the Free Standing Track.

⚠ FAILURE TO COMPLY WITH THIS MAY RESULT IN INJURY TO THE INDIVIDUAL BEING LIFTED AND/OR THE CAREGIVER, OR DAMAGE TO THE LIFT AND/OR THE FREE STANDING TRACK.

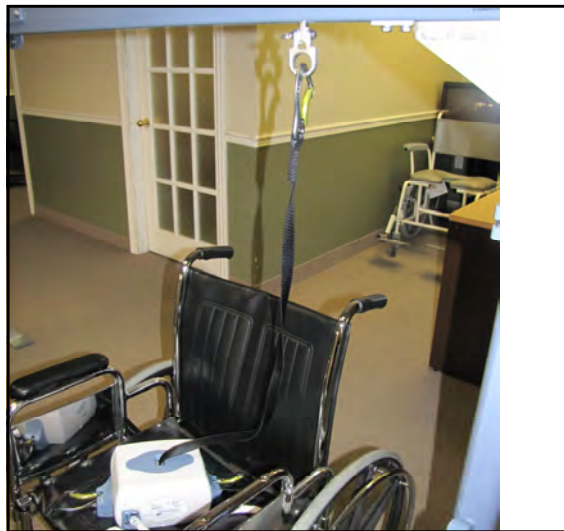
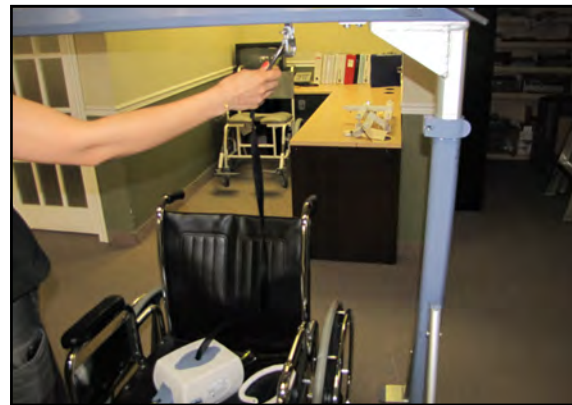
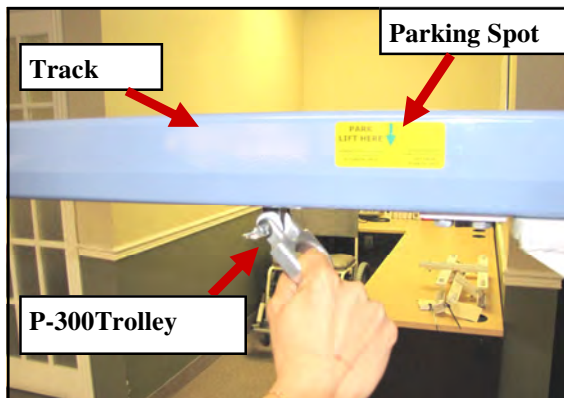

Grab the Trolley eyelet and bring it to the parking spot. Once the trolley is in parking spot, Place the Portable lift in secure and comfortable position. Pull enough strap out of the lift to be able to hook the carabineer comfortably to the eyelet of the trolley. Put the carabineer of the lift strap into the eyelet of the trolley as shown in figure above. Raise the lift to the track height.

Note: always make sure that the lift is in parking spot before raising the posts.

Apply load and pull the lift down to be able to remove the lift from parking spot and use it.

Raising up the Free Standing Track



Step 1 - Grab The Post Centre to open the post clamp



Step 2 - Fully Open The clamp



Step 3 - Grab The Inner Post with one hand and grab the Outer Post section with the other hand.

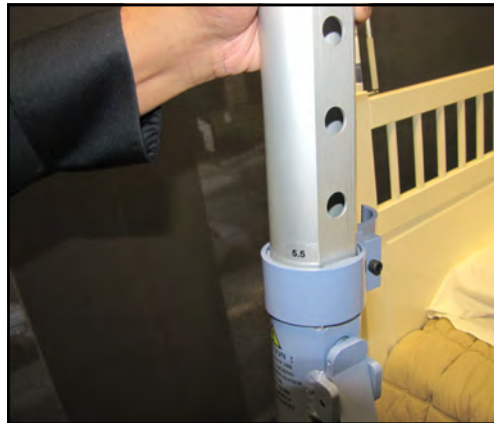

Step 4: Raise the Post Up using the height indicators.



Step 5 - Repeating steps 1-5, raise the other Post.

Note: When Raising the Post from Lowest setting, it is recommended to raise in 1 Foot increments.

Raising up the Free Standing Track Continued...



Note: Free Standing Track will be in a slanting position as shown in figure. Set up the Free Standing Track by raising the post assemblies one by one.



 **Note:** a caution sign at the 7 feet indicates that you are approaching the end of the post. Carefully extend the post until you approach the stop sign or 7.5 feet if desired or applicable.



Max Height of Free Standing Track

 **Do not extend post after 7.5 Feet height mark.**

Note: Maximum height of Free Standing Track is 7.5 Feet.

Raising up the Free Standing Track Continued...



Step 6 - Close the post clamp as shown in figure.



Step 7 - Make sure the clamp is fully closed on both posts.



Completely Installed Free Standing Track



Always Before Use check the following steps:

- 1) **Make sure the height indicator shows the same number on both posts.**
- 2) **No Gap between Track and track Holder.**
- 3) **No Gap Between Foot Pads and Floor.**

Attaching the Skirt- Optional Accessory



Step 1 - Rap the skirt around the legs and close it using the Velcro hooks.



Step 2 - Use the pocket as a storage for the sling or as you require.

Disassembly of Free Standing Track



Step 1 - Before disassembly , make sure the lift and /or Trolley is in parking spot.



Step 2 - Grab The Post Centre to open the post clamp and fully open the clamp.



Step 3 - Grab The Post and press the Ratchet with thumb.



Step 4 - Bring down the Free Standing Track by sliding down the inner Post while keep pressing down the Ratchet Lock.

Note: When Lowering down the Post from highest setting, it is recommended to lower in 1 Foot increments.



To prevent sudden drop of the post you should release the ratchet in at least every 12” (or every 6 holes). Failure to do this step might cause injury or damage to the floor.

Disassembly of Free Standing Track

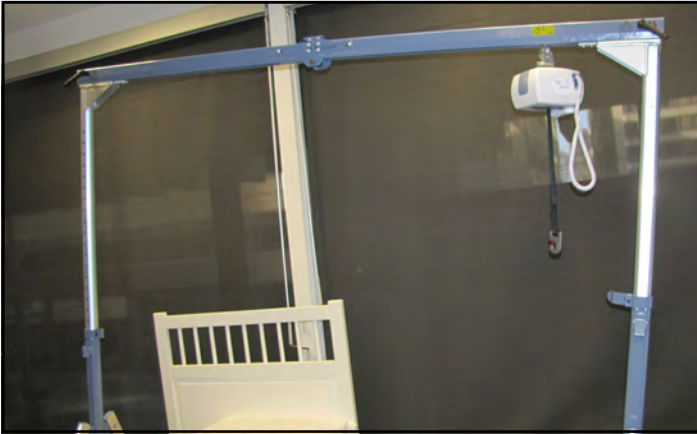

Note: Free Standing Track will be in a slanting position as shown in figure. Bring down the other side of the Free Standing Track following steps 2-5.

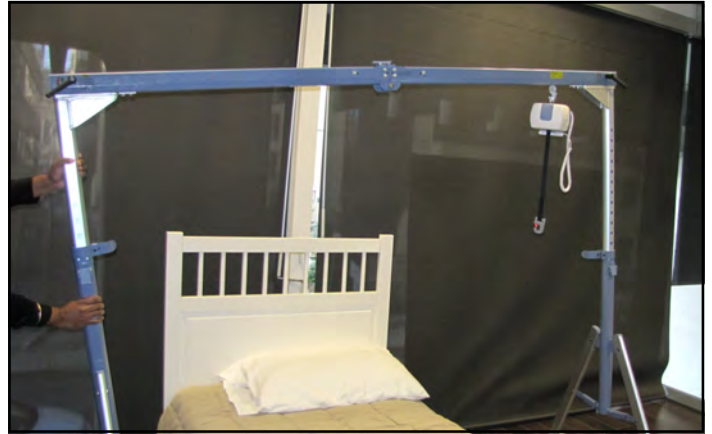

Note: Make sure the posts are parallel and not twisted inside each other. Failing to do that, user might experience resistance in lowering down the posts.



Step 5 - Bring the Free Standing Track to the shoulder height and dismantle the lift from the trolley following the user manual of the lift.



Step 6 - Push the safety lock button to unlock the track from Post assembly.

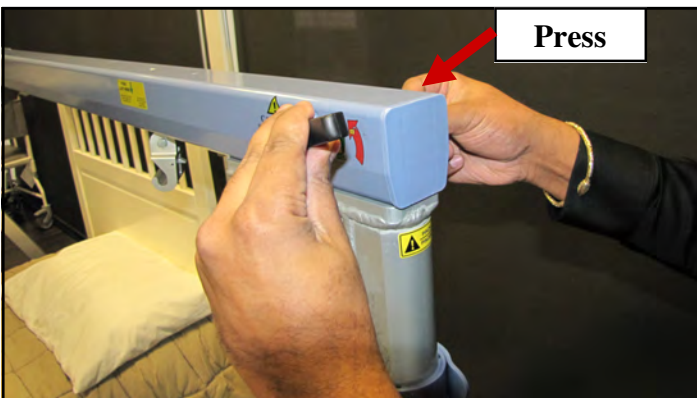

Step 7 - Press the Push button and Twist handle in unlock direction at the same time.



Step 8 - Repeat step 11 & 12 for other end to unlock the track from both ends.

Disassembly of Free Standing Track



Step 9 - Lift The track up from post assembly and place it on the floor.



Step 10 - Press the Track lock hook as shown in figure to fold the track. While holding the lock , slightly fold the track .

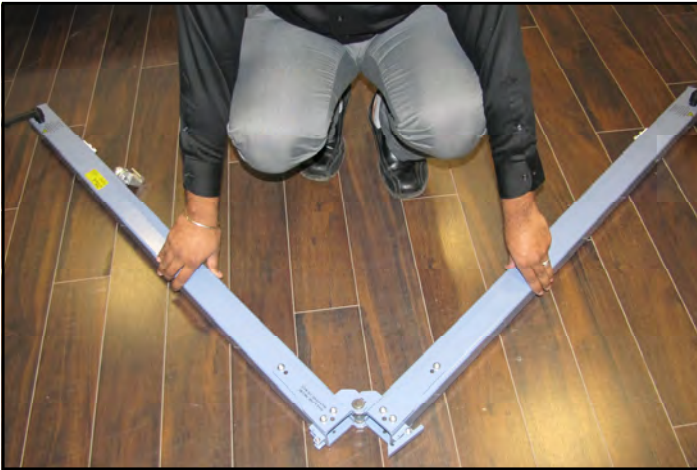

Step 11 - Let go of the lock and fold the track.



Step 16 - Close the track fully.

Disassembly of Legs



Step 1 - Pull the hinge slightly upwards as shown in figure.



Caution: Do not place your finger underneath the hinge it might get

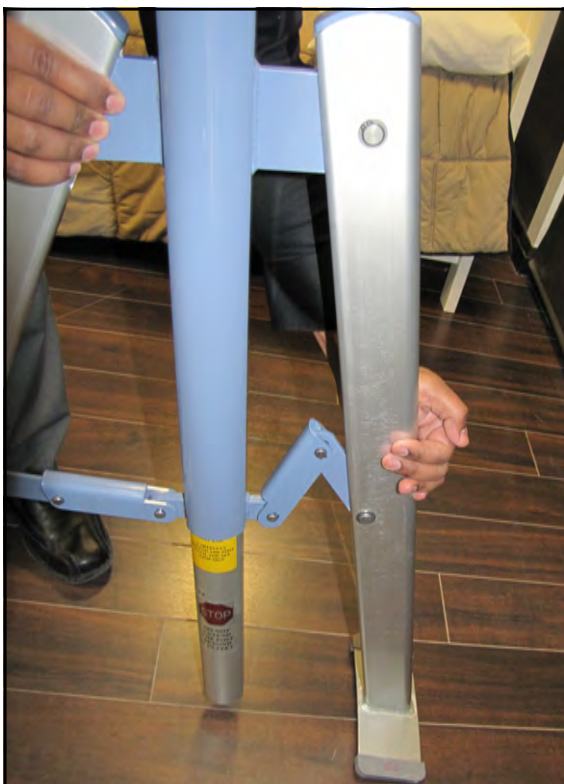

Step 2 - Grab The side leg and press in as shown in figure. Repeat the step 1 and 2 for the other side



Step 3 - Fully closed legs. Repeat the steps 1 to 3 for the other leg and post assembly.

Trolley Disassembly

Removing Trolley C-300 (Prism part number 330051)

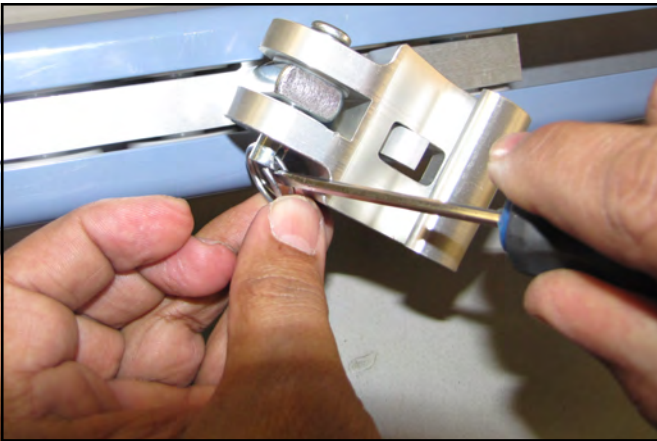

Step 1– Remove the split ring as shown in figure .



Step 2– Detach the hook of the C-300 by taking the pin out as shown in figure .

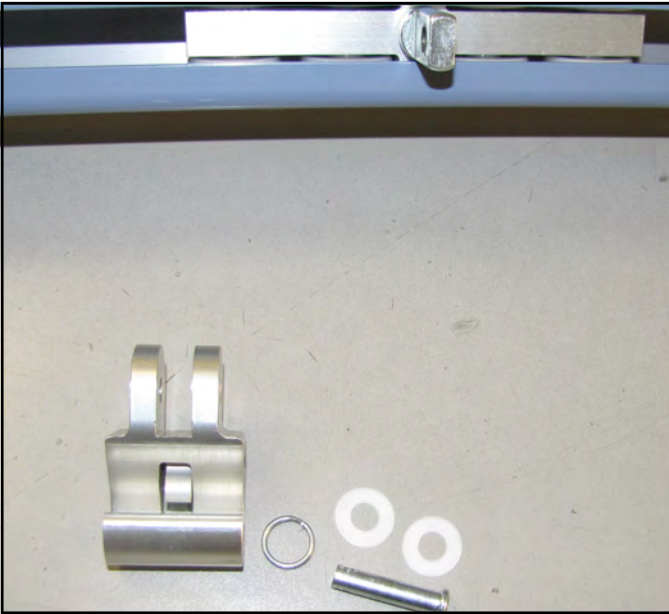

Step 3– Make sure not to lose any part.

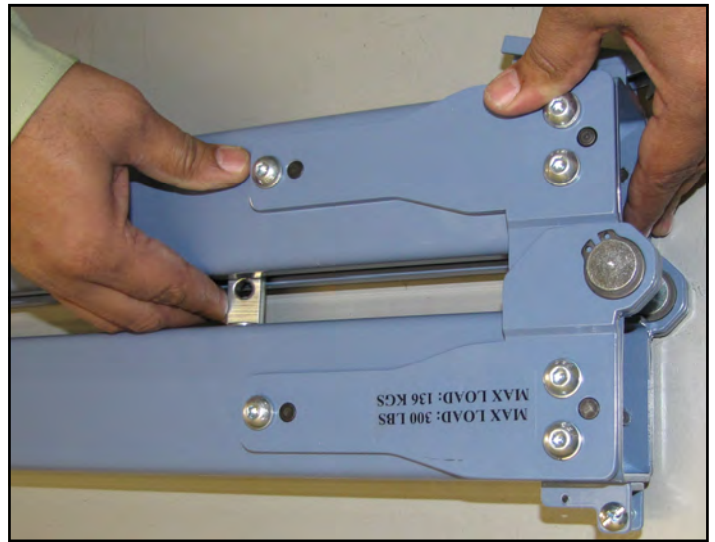

Step 4– Fold and place the track on the floor or on a secure table. Bring the trolley to the opening of the track.

Trolley Disassembly Continued...

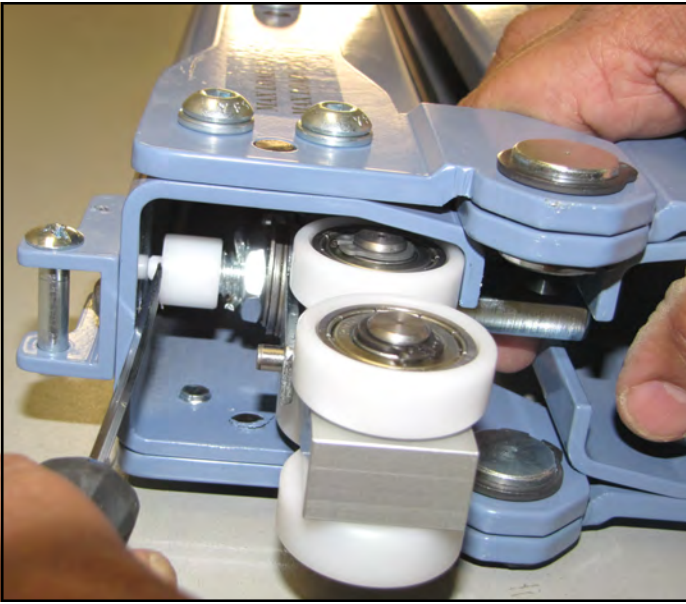

Step 5– Use a screw driver and push the trolley lock button down to allow the trolley to come out.

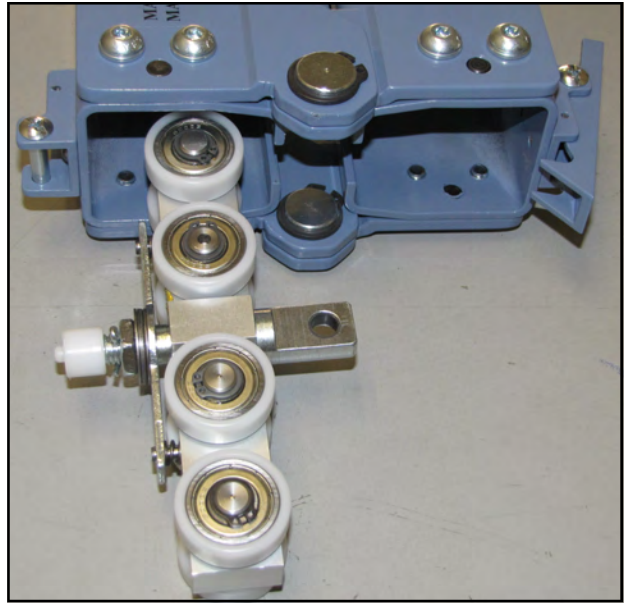

Step 6– Remove the trolley.

Removing Trolley P-300 (Prism part number 330052)



Step 1– Follow the step 1 to 6 from the removing trolley C-300.



Note: Make sure not to loose any part.

Trouble Shooting

Should problems arise with the use of the Free Standing Track review the following chart. Find the fault and complete the recommended solution. If the fault is not found and/or the solution does not correct the problem contact your local authorized dealer for service immediately.

Fault	Reason	Recommended Solution
Visually the system is not aligned straight.	<ol style="list-style-type: none"> 1. Post is not set straight. 2. Floor is not leveled. 	<ol style="list-style-type: none"> 1) Set up the post following Post Assembly instructions. <p>Note: Make sure the track is seating completely flat on the track holder.</p> <ol style="list-style-type: none"> 2) Foot pads must be seating completely flat on the floor. There should be no gap between the foot and floor pads. <p>If problem persists, contact your local authorized dealer immediately.</p>
Feet are slipping after installation.	<ol style="list-style-type: none"> 1. Feet are not cleaned. 2. Floor is not cleaned. 	<ol style="list-style-type: none"> 1) Clean the feet as per “Cleaning Rubber Feet Instructions”. 2) Ensure floor area is dry and free of debris . <p>If problem persists, contact your local authorized dealer immediately .</p>
Clamp Lever can not be fully closed.	<ol style="list-style-type: none"> 1. Clamp bolt is tight 	<ol style="list-style-type: none"> 1) Open the Clamp Lever and use 3/16” Allen key to loose the bolt one turn each time. Close the clamp lever and see if closes fully. After closing the clamp press the ratchet. You should not be able to open the ratchet. If the ratchet gets open while the clamp is fully closed, it means that you have loosen the bolt too much. Tight the bolt back till you are not able to open the latch. <p>Note: Do not loose bolt too much. If problem persists, contact your local authorized dealer immediately .</p>
The Folded Track does not sit properly on the post assemblies.	<ol style="list-style-type: none"> 1. Physical damage to track. 2. Handle lock is in lock position. 	<ol style="list-style-type: none"> 1) Check for physical damage to track. If so, contact local authorized dealer immediately. 2) Follow the track assembly instructions and open the handle lock. 3) Posts are not parallel or not standing completely straight.
Trolley does not move smoothly along the adjustable track.	<ol style="list-style-type: none"> 1. Physical damage to track or trolley wheels. 2. Track slots or trolley wheels are not cleaned. 	<ol style="list-style-type: none"> 1) Visually make sure tracks and wheels are not damaged. 2) Ensure that tracks are cleaned with cloth and free of dirt. <p>If problem persists, contact local authorized dealer immediately.</p>
Trolley does not park	<ol style="list-style-type: none"> 1. Parking hole is filled with dirt or debris. 2. Trolley spring is damaged. 3. Trolley lock button is damaged. 	<ol style="list-style-type: none"> 1) Clean the hole with cloth and remove dirt or debris. 2) Contact local authorized dealer. 3) Contact local authorized dealer immediately.
The folded track is not locking on the Post assembly.	<ol style="list-style-type: none"> 1. Track Handle Lock hook damaged or broken. 2. Track Handle Lock Push button damaged or broken. 	<p>Do not use the system. Contact your local authorized dealer immediately.</p>

Ratchet sticks out when lowering or raising and dose not lock	1. Ratchet spring is damaged	1) Do not use the system. Contact your local authorized dealer immediately.
Track Lock Not working.	1. Physical damage to track lock assembly. 2. Track Lock Spring breaks or damaged.	1) Unfold the Track and the fold it together to see if the track lock set it self in locking position or not. If not then contact local authorized dealer immediately. 2) Do track assembly steps and see the if the track locks or not. If not then contact local authorized dealer immediately.
Ratchet can be pushed out when the clamp lever is locked	1. Clamp bolt is loose	1) Open the Clamp Lever and use a 3/16" Allen key to tight the bolt one turn at a time. Close the clamp lever and then push the Ratchet to see if it opens up. Note: Do not over tight the bolt. You should be still able to close the clamp lever without any problem. If problem persists, contact your local authorized dealer immediately.

FAQs

Question: The Free Standing Track seems unstable. Should I be worried?

Answer: No, you should not be worried/concerned. Provided the Free Standing Track has been installed per the manuals specifications. After spending some time with the device, especially once a client has become accustomed to the device, the lateral stability issue will be less obvious.

Question: How stable is the device?

Answer: This device has been tested as per ISO 10535 requirements for Free Standing Hoists. This testing includes; a 10 degree tilts test (on all four sides) with 375lbs (300lbs safe working load x 1.25).The hoist has passed all testing procedures.

Question: Is the device strong enough to stand the load of 300lbs?

Answer: This device has been tested to maximum load of 450lbs (300lbs safe working load x 1.5). The hoist has passed the test with no sign of defect.

Question: If the floor has a slope, will the trolley slide towards the direction of slope by itself ?

Answer: A braking mechanism is integrated to the design of the trolley which prevents it from sliding unintentionally. You need to apply force to be able to move the trolley to the desire location.

General Inspection and Maintenance



Failure to follow inspection and maintenance instructions below may result in serious injury or death.

Periodic general inspection and maintenance should be performed by a person who is properly qualified and trained with the use and care of The Free Standing Track System.

Any defects and damage to the Free Standing Track that have lead to corrective actions should be noted and dated by the inspector. The defects and corrective actions report should be submitted in written form to the dealer.

Upon Receipt of The Free Standing Track system:

- Ensure all the received components are according to the component list.
- Ensure the user manual is present otherwise do not install the Free Standing Track system.
- Ensure all the components are in working condition and not damaged.
- Ensure service record history forms are included in the package to record any completed service and repairs.
- Complete the **Purchase and Service Information** as soon as this equipment is installed.

Each Use– To be completed by user

Prior to each use, the Free Standing Track and associated lift, accessories and sling (s), must be visually inspected. Refer to the lift, accessory and sling user guides for specific details regarding their inspection.

Should any of these items below fail the inspection do not use the Free Standing Track
Contact your local authorized dealer for service.

Visually check for the following:

- Ensure all the components of Free Standing Track System are in working condition. If damaged, please contact the dealer for replacement before use.
- All 4 feet are on a stable, level surface and the supporting post assemblies are secure.
- Check rubber feet for damages. If damage is noticed , please contact dealer for replacement. Make sure that they are clean before placing them on the floor. (refer to cleaning rubber feet instruction)
- The Post clamps are locked.
- The ratchets are locked
- The handles are locked
- The trolley moves easily along the track.
- The adjustment track is placed in the correct location for transferring.
- Ensure the labels are legible and in good condition. If not contact dealer for replacement.
- Record the service record history form for any completed service and repairs.
- Ensure that the service record is signed and dated each time it is used.
- The portable lift has been inspected as outlined in it's owners manual.
- The sling (s) has been inspected as outlined in it's owners manual.

Service Record History - Initial Information

- Complete the following section- **Purchase and Service Information** as soon as this equipment is installed.
- Use the service record history to record any completed service and repairs.
- Ensure that the service record is signed and dated each time it is used.
- Be sure to have this piece of equipment serviced on a regular basis as described in the General Inspection and Maintenance Section

PURCHASE INFORMATION:

Product Name: Free Standing Track System

Serial#: _____

Date of Purchase: _____

Date Installed: _____

Purchased From: _____

Address: _____

City: _____

Post Code: _____

Telephone No: _____

Comments:

SERVICE INFORMATION:

Contact the following company for service:

Company: _____

Address: _____

City: _____

Post Code: _____

Telephone No: _____

Comments:

Service Record History

Complete this section after each service, repair inspection and/or maintenance. Photocopy additional pages as required.

Date: _____		Time: _____	
Service Type: <input type="checkbox"/> Periodic Inspection <input type="checkbox"/> Monthly Inspection <input type="checkbox"/> 6 Month Inspection <input type="checkbox"/> Repair <input type="checkbox"/> Yearly Inspection <input type="checkbox"/> Other: _____			
Completed By: _____		_____	
Printed Name		Signature	
Company: _____			
Remarks & Action Taken:			

Date: _____		Time: _____	
Service Type: <input type="checkbox"/> Periodic Inspection <input type="checkbox"/> Monthly Inspection <input type="checkbox"/> 6 Month Inspection <input type="checkbox"/> Repair <input type="checkbox"/> Yearly Inspection <input type="checkbox"/> Other: _____			
Completed By: _____		_____	
Printed Name		Signature	
Company: _____			
Remarks & Action Taken:			

Date: _____		Time: _____	
Service Type: <input type="checkbox"/> Periodic Inspection <input type="checkbox"/> Monthly Inspection <input type="checkbox"/> 6 Month Inspection <input type="checkbox"/> Repair <input type="checkbox"/> Yearly Inspection <input type="checkbox"/> Other: _____			
Completed By: _____		_____	
Printed Name		Signature	
Company: _____			
Remarks & Action Taken:			

Date: _____		Time: _____	
Service Type: <input type="checkbox"/> Periodic Inspection <input type="checkbox"/> Monthly Inspection <input type="checkbox"/> 6 Month Inspection <input type="checkbox"/> Repair <input type="checkbox"/> Yearly Inspection <input type="checkbox"/> Other: _____			
Completed By: _____		_____	
Printed Name		Signature	
Company: _____			
Remarks & Action Taken:			

Date: _____		Time: _____	
Service Type: <input type="checkbox"/> Periodic Inspection <input type="checkbox"/> Monthly Inspection <input type="checkbox"/> 6 Month Inspection <input type="checkbox"/> Repair <input type="checkbox"/> Yearly Inspection <input type="checkbox"/> Other: _____			
Completed By: _____		_____	
Printed Name		Signature	
Company: _____			
Remarks & Action Taken:			

Date: _____		Time: _____	
Service Type: <input type="checkbox"/> Periodic Inspection <input type="checkbox"/> Monthly Inspection <input type="checkbox"/> 6 Month Inspection <input type="checkbox"/> Repair <input type="checkbox"/> Yearly Inspection <input type="checkbox"/> Other: _____			
Completed By: _____		_____	
Printed Name		Signature	
Company: _____			
Remarks & Action Taken:			

Service Record History

Complete this section after each service, repair inspection and/or maintenance. Photocopy additional pages as required.

Date: _____		Time: _____	
Service Type: <input type="checkbox"/> Periodic Inspection <input type="checkbox"/> Monthly Inspection <input type="checkbox"/> 6 Month Inspection <input type="checkbox"/> Repair <input type="checkbox"/> Yearly Inspection <input type="checkbox"/> Other: _____			
Completed By: _____		_____	
Printed Name		Signature	
Company: _____			
Remarks & Action Taken:			

Date: _____		Time: _____	
Service Type: <input type="checkbox"/> Periodic Inspection <input type="checkbox"/> Monthly Inspection <input type="checkbox"/> 6 Month Inspection <input type="checkbox"/> Repair <input type="checkbox"/> Yearly Inspection <input type="checkbox"/> Other: _____			
Completed By: _____		_____	
Printed Name		Signature	
Company: _____			
Remarks & Action Taken:			

Date: _____		Time: _____	
Service Type: <input type="checkbox"/> Periodic Inspection <input type="checkbox"/> Monthly Inspection <input type="checkbox"/> 6 Month Inspection <input type="checkbox"/> Repair <input type="checkbox"/> Yearly Inspection <input type="checkbox"/> Other: _____			
Completed By: _____		_____	
Printed Name		Signature	
Company: _____			
Remarks & Action Taken:			

Date: _____		Time: _____	
Service Type: <input type="checkbox"/> Periodic Inspection <input type="checkbox"/> Monthly Inspection <input type="checkbox"/> 6 Month Inspection <input type="checkbox"/> Repair <input type="checkbox"/> Yearly Inspection <input type="checkbox"/> Other: _____			
Completed By: _____		_____	
Printed Name		Signature	
Company: _____			
Remarks & Action Taken:			

Date: _____		Time: _____	
Service Type: <input type="checkbox"/> Periodic Inspection <input type="checkbox"/> Monthly Inspection <input type="checkbox"/> 6 Month Inspection <input type="checkbox"/> Repair <input type="checkbox"/> Yearly Inspection <input type="checkbox"/> Other: _____			
Completed By: _____		_____	
Printed Name		Signature	
Company: _____			
Remarks & Action Taken:			

Date: _____		Time: _____	
Service Type: <input type="checkbox"/> Periodic Inspection <input type="checkbox"/> Monthly Inspection <input type="checkbox"/> 6 Month Inspection <input type="checkbox"/> Repair <input type="checkbox"/> Yearly Inspection <input type="checkbox"/> Other: _____			
Completed By: _____		_____	
Printed Name		Signature	
Company: _____			
Remarks & Action Taken:			

Service Record History

Complete this section after each service, repair inspection and/or maintenance. Photocopy additional pages as required.

Date: _____		Time: _____	
Service Type: <input type="checkbox"/> Periodic Inspection <input type="checkbox"/> Monthly Inspection <input type="checkbox"/> 6 Month Inspection <input type="checkbox"/> Repair <input type="checkbox"/> Yearly Inspection <input type="checkbox"/> Other: _____			
Completed By: _____		_____	
Printed Name		Signature	
Company: _____			
Remarks & Action Taken:			

Date: _____		Time: _____	
Service Type: <input type="checkbox"/> Periodic Inspection <input type="checkbox"/> Monthly Inspection <input type="checkbox"/> 6 Month Inspection <input type="checkbox"/> Repair <input type="checkbox"/> Yearly Inspection <input type="checkbox"/> Other: _____			
Completed By: _____		_____	
Printed Name		Signature	
Company: _____			
Remarks & Action Taken:			

Date: _____		Time: _____	
Service Type: <input type="checkbox"/> Periodic Inspection <input type="checkbox"/> Monthly Inspection <input type="checkbox"/> 6 Month Inspection <input type="checkbox"/> Repair <input type="checkbox"/> Yearly Inspection <input type="checkbox"/> Other: _____			
Completed By: _____		_____	
Printed Name		Signature	
Company: _____			
Remarks & Action Taken:			

Date: _____		Time: _____	
Service Type: <input type="checkbox"/> Periodic Inspection <input type="checkbox"/> Monthly Inspection <input type="checkbox"/> 6 Month Inspection <input type="checkbox"/> Repair <input type="checkbox"/> Yearly Inspection <input type="checkbox"/> Other: _____			
Completed By: _____		_____	
Printed Name		Signature	
Company: _____			
Remarks & Action Taken:			

Date: _____		Time: _____	
Service Type: <input type="checkbox"/> Periodic Inspection <input type="checkbox"/> Monthly Inspection <input type="checkbox"/> 6 Month Inspection <input type="checkbox"/> Repair <input type="checkbox"/> Yearly Inspection <input type="checkbox"/> Other: _____			
Completed By: _____		_____	
Printed Name		Signature	
Company: _____			
Remarks & Action Taken:			

Date: _____		Time: _____	
Service Type: <input type="checkbox"/> Periodic Inspection <input type="checkbox"/> Monthly Inspection <input type="checkbox"/> 6 Month Inspection <input type="checkbox"/> Repair <input type="checkbox"/> Yearly Inspection <input type="checkbox"/> Other: _____			
Completed By: _____		_____	
Printed Name		Signature	
Company: _____			
Remarks & Action Taken:			

